



The Mammal Society Research Report No. 6

**Proposal for a National Monitoring Scheme
for Small Mammals
in the United Kingdom and the Republic of Eire**

Stephen Sibbald, Phoebe Carter & Simon Poulton

January 2006

© The Mammal Society

The Mammal Society Research report No. 6

ISBN: 0 906282 60 8

Registered Charity No. 278918

Registered Office:
2B Inworth Street
London SW11 3EP

Contents

1	Introduction	5
1.1	The Requirement for a Small Mammal Monitoring Programme	5
1.1.1	Small mammals and conservation	5
1.1.2	Small mammals as prey species	5
1.1.3	Small mammals as indicators of agricultural change	5
1.1.4	Small mammals as pest species	6
1.2	Background to Multi-Species Schemes	7
1.3	Aims and objectives	9
2	Species Accounts	10
2.1	Order Insectivora	11
2.1.1	Common shrew <i>Sorex araneus</i>	11
2.1.2	French shrew (Millet's shrew) <i>Sorex coronatus</i>	12
2.1.3	Pygmy shrew <i>Sorex minutus</i>	13
2.1.4	Water shrew <i>Neomys fodiens</i>	14
2.1.5	Lesser white-toothed shrew <i>Crocidura suaveolens</i>	16
2.1.6	Greater white-toothed shrew <i>Crocidura russula</i>	18
2.2	Order Rodentia	19
2.2.1	Bank vole <i>Clethrionomys glareolus</i>	19
2.2.2	Field vole <i>Microtus agrestis</i>	20
2.2.3	Orkney and Guernsey vole <i>Microtus arvalis</i>	22
2.2.4	Wood mouse <i>Apodemus sylvaticus</i>	24
2.2.5	Yellow-necked mouse <i>Apodemus flavicollis</i>	25
2.2.6	Harvest mouse <i>Micromys minutus</i>	27
2.2.7	House mouse <i>Mus domesticus</i>	29
3	Evaluation of Field Methods	31
3.1	Introduction	31
3.2	Live trapping	31
3.2.1	Longworth trap	32
3.2.2	Sherman trap	33
3.2.3	Ugglan trap	34
3.2.4	Trip-Trap	36
3.2.5	Wellfield trap	37
3.2.6	Havahart trap	37
3.2.7	Pitfall trap	38
3.2.8	Questionnaire Survey Results	39
3.3	Owl pellet analysis	42
3.3.1	Disadvantages of owl pellet analysis	43
3.3.2	Other owl species	43
3.3.3	Questionnaire Survey Results	44
3.4	Faecal tubes/bait tubes	46
3.4.1	Advantages of faecal tubes/bait tubes	46
3.4.2	Disadvantages of faecal tube/bait tubes	47
3.4.3	Questionnaire Survey Results	47
3.5	Hair tubes	49
3.5.1	Description of the Method	49
3.5.2	Advantages of hair tubes	51
3.5.3	Disadvantages of hair tubes	51
3.5.4	Questionnaire Survey Results	51
3.6	Field sign searches	54
3.6.1	Types of field sign	54
3.6.2	Advantages of field sign searches	55
3.6.3	Disadvantages of field sign searches	55

3.6.4	Questionnaire Survey Results	56
3.7	Other survey methods	58
3.7.1	Cat predation	58
3.7.2	Scentinel bait station	58
3.7.3	Dormouse nest box records	59
3.7.4	Questionnaire Survey Results	59
3.8	Summary	62
4	Survey Design	63
4.1	Introduction	63
4.2	Sampling Strategy	64
4.2.1	Sampling and Stratification	64
4.2.2	Primary Sampling Units	65
4.2.3	Secondary Sampling Units	66
4.2.4	Number and location of SSUs within PSUs	69
4.3	Temporal Factors	70
4.4	Power Analysis	71
4.4.1	Rates of Decline	71
4.4.2	Types of data obtained	72
4.4.3	The Simulations	73
4.4.4	Power analysis for PA-ratios	73
4.4.5	Power analysis for Count data	75
4.4.6	Discussion	75
4.5	Summary	78
4.5.1	Statistical Advantages	78
4.5.2	Advantages for Volunteers	78
5	Recommendations	79
5.1	Two-Year Pilot Scheme	79
5.1.1	Costings	79
5.2	National Small Mammal Monitoring Programme	80
5.2.1	Costings	80
6	Acknowledgements	82
7	References	83
7.1	Personal communications	90

1 Introduction

1.1 *The Requirement for a Small Mammal Monitoring Programme*

Small mammals are an essential component of most terrestrial ecosystems. Monitoring is particularly important for this group of species in the UK because for many of them there is insufficient evidence for them to be assessed as part of the UK BAP process. This report proposes a unified approach to the monitoring of small mammals in UK and the Republic of Eire. There are a number of reasons why we maintain that such a programme is highly valuable and long overdue.

1.1.1 Small mammals and conservation

There is insufficient data on the majority of our small mammal species to be able to assess their conservation needs. One of the species for which there is concern is the harvest mouse, which has been proposed as a UK BAP species. However, more information about this species is urgently needed and the proposed national survey would seem to be the only, effective, unified method for collecting this information.

We have also included within the remit of the report the scarcer island species, such as the shrews of the Scilly and Channel Isles and the voles of Orkney and Guernsey. Although these species are not uncommon on mainland Europe, they represent outlying populations and considerably increase the biodiversity of the UK and Ireland.

1.1.2 Small mammals as prey species

Barn owls, and to a lesser extent other owl and raptor species, rely heavily on small mammals for their survival. Small mammals are also important for some of Britain's scarcer carnivore species. For instance, the wildcat, pine marten and weasel are all proposed as priority species in the UK BAP review. Small mammals make up between 18 and 32% of the diet of the pine marten (Birks, 2002); mice and voles make up to 47% of the diet of the wildcat (Kitchener, 1995), and up to 90% of the diet of the weasel is small mammals (McDonald & Harris, 1998). As small mammals comprise such a large proportion of the diet of these threatened carnivores it is imperative that we implement a scheme to monitor their populations and thus contribute to the conservation of these carnivores.

1.1.3 Small mammals as indicators of agricultural change

Several small mammals appear to be affected by changes in agricultural practices. Bank voles are thought to be affected by pesticide drift into field margins (MacDonald & Tattersall, 2001). Field voles may be threatened by increased grazing pressure from stock, loss of rough grassland, the removal of linear features and loss of "marginal land" due to development (Battersby, 2005). The Orkney vole is an endemic species and is vulnerable to habitat loss and fragmentation through agricultural development (Harris, Morris, Wray & Yalden, 1995). Harvest mice are thought to be affected by changes in agricultural practices and management (MacDonald & Tattersall, 2002).

The monitoring programme will include the collection of data on agri-environment schemes, farming practices and agricultural habitat. This will allow the influence of these factors on small mammal populations to be investigated.

1.1.4 Small mammals as pest species

Field voles and bank voles are known to attack young trees up to about 5cm in diameter and can cause considerable damage to broadleaved trees, pines, larches and even young Sitka spruce. They strip bark from roots and lower stems and bank voles are capable of climbing and may cause damage up to 4m high. Severe damage can cause death of the tree and less severe damage may allow fungal infections to enter the wood. Not only is the loss of trees ecologically damaging, but the preventative measures to ensure that trees are protected are costly.

Wood mice can cause considerable economic damage to agriculture by consuming newly sown seeds and contamination of animal feed by faeces and urine. They have also been documented as carrying bTB (NFBG, 2004) and they carry a range of other zoonotic diseases including Weil's disease (leptospirosis). They are also a common species found in homes where they can cause damage to woodwork and electrics.

Yellow-necked mice have been linked to the spread of Tick Borne Encephalitis (TBE) across continental Europe and there may implications for the UK if the climate becomes warmer and the species is able to spread northwards across the UK (Battersby, 2005).

House mice are economically important in Great Britain as they can cause extensive physical damage to buildings and wiring, and are known to consume and contaminate stored products. They carry several diseases including *Salmonella*, *Cryptosporidium* and *Leptospirosis* (MacDonald & Tattersall, 2001) and thus can pose a considerable health risk to humans.

1.2 Background to Multi-Species Schemes

In recent years, small mammal surveys in the UK have focused on individual species or ecologically related species (e.g. Marsh, 1999; Marsh, Poulton & Harris, 2001). Monitoring has also tended to be short-term or regionally targeted (e.g. Greenwood, Churchfield & Hickey, 2002). Multi-species schemes are a well-established approach to bird monitoring (e.g. Breeding Bird Survey, British Trust for Ornithology/Joint Nature Conservancy Committee/Royal Society for the Protection of Birds). These schemes have demonstrated that a co-ordinated survey network using a volunteer workforce is an effective method of obtaining long-term monitoring data.

Multi-species schemes for mammals are, however, more complex than those for birds. For the latter, a single field method recording sightings or singing birds, can be used for all species. But, a variety of different field methods and sampling strategies are required to ensure that mammal species are monitored comprehensively. This increases the complexity of the survey design which may lead to a reduced volunteer network in comparison to bird monitoring schemes. Volunteers on bird surveys are almost guaranteed a bird sighting while mammal survey volunteers will often not see any individuals and have to make do with indirect evidence, for example, tracks or droppings. This is considered to be one of the main reasons that mammal surveys often have fewer volunteers than bird surveys and why mammal surveys may appear less successful than those of birds.

The Mammal Society, other NGOs and statutory bodies have, however, developed and launched an integrated national strategy for mammals through *The Tracking Mammals Partnership* (TMP) (Battersby & Greenwood, 2004). The TMP aims to establish co-ordinated, nationwide networks of volunteers to undertake surveillance and monitoring, enabling them to deliver distribution and population trend information on all UK mammals. It also aims, where possible, to standardise survey designs and methods to facilitate information exchange. The scheme proposes that small mammals should be monitored on an annual basis, using volunteers to collect data on population indices. A decline has been suggested in small mammal species such as the harvest mouse (Sargent, 1999) and the common shrew (Love, Webbon, Glue & Harris, 2000). The water shrew has been listed as a 'species of conservation concern' (SoCC) by the Joint Nature Conservancy Committee. Collecting data on annual population trends on these and other species will help set priorities for conservation and better inform policy and management for the future (Battersby & Greenwood, 2004).

Most mammal surveys rely upon a voluntary workforce and the variety of techniques available for monitoring small mammals, and their differing complexities, could restrict volunteer participation. Survey design needs to be structured in such a way as to encourage volunteer involvement and retain their interest, ensuring continuity of data collection and longevity of the scheme. Multi-species schemes can be popular among volunteers as there is potential for encountering a variety of species while surveying. Survey design should be easily repeatable at regular intervals to provide consistent and accurate records to minimise bias. Field methods for obtaining small mammal data range from direct techniques, such as live trapping programmes, to indirect methods including feeding signs, droppings and nest counts. However, most surveys are inevitably influenced by the availability of funding, and this will dictate, and can often compromise, the choice of method used. Unifying survey methods is a cost effective way of spreading budgets across a range of species (Macdonald, Mace & Rushton, 1998; Toms, Siriwardena & Greenwood, 1999).

Multi-species schemes are intended to quantify long-term species trends in populations across a range of habitats. Many species have restricted habitat preferences (e.g. harvest mice), and differences in habitat usage/type should be taken into consideration when designing a monitoring scheme. Likewise, consideration should be given to the island shrews (*Crocidura* spp & *Sorex coronatus*) and voles (*Microtus arvalis*) as these species have limited habitat preferences and UK

distributions. Even where species do occur together, simultaneous monitoring may be hampered by other factors such as differing foraging habitats (Flowerdew *et al.*, 2004).

Small mammal surveying was considered as part of a national mammal monitoring scheme for the UK by Macdonald *et al.* in 1998 and Toms *et al.* in 1999. These reports considered live trapping the key technique for monitoring small mammal populations but trapping protocol and the number of sites required for a national monitoring scheme were less clearly defined (Flowerdew *et al.*, 2004). The involvement of volunteers of different abilities was also not considered. It is worth noting that there has been considerable development in the range of survey techniques available since the publication of the aforementioned reports. Recent innovations have included the use of baited tubes for water shrews, small mammal camera traps and the DNA testing of hair samples to identify a range of species.

1.3 Aims and objectives

The overall aim of the current study is to recommend the best method of monitoring small mammals in the UK using the same sampling strategy and the minimum number of field methods to monitor as many species as possible on a long-term scale. While the study is UK wide, it will also include the Channel Islands as they are not being covered at present.

The species accounts provide a summary of the existing knowledge on the biology and ecology of each species and, in addition, summarise information about the past and current surveys used to monitor them. This is particularly important as knowledge of the survey methods that have been used in previous surveys and an understanding of the species distribution, habitat occurrence and breeding seasons is essential to design a suitable and effective survey.

The report then outlines the field techniques that can be used to obtain data on small mammal populations and their distribution and abundance. The advantages and disadvantages of each method will be discussed in terms of the species they can monitor, volunteer effort, costs and analytical effort. This section includes the results of a questionnaire survey designed specifically for this contract. Finally, recommendations will be made as to how a national Small Mammal Monitoring Scheme should be run, including the best combination of field methods, details of the numbers of sites and volunteers that would be needed, and the costs of running such a scheme.

2 Species Accounts

The species to be included in this monitoring scheme either belong to the orders Insectivora or Rodentia. However, certain species have been excluded from the target species list for a variety of reasons. Firstly, of the Insectivores, the hedgehog (*Erinaceus europaeus*) has been excluded due to its size and the mole (*Talpa europaea*), due to its unique habitat requirements. Of the rodents, the two arboreal squirrel species (*Sciurus vulgaris* and *S. carolinensis*) have been excluded due to their habitat requirements and the two rat species (*Rattus norvegicus* and *R. rattus*) due largely to their size.

Of the remaining species, existing and comprehensive surveys are currently being undertaken for three; the water vole (*Arvicola terrestris*), the hazel dormouse (*Muscardinus avellanarius*), and the edible dormouse (*Glis glis*). As there are already well established monitoring schemes for these species including them in a national Small Mammal Monitoring scheme would result in unnecessary replication of effort. The remaining 13 species of small mammal that will be included in the Small Mammal Monitoring scheme are listed below.

Table 1. Species covered in the current report

<i>Common name</i>	<i>Latin name</i>
<i>Insectivora</i>	
Common shrew	<i>Sorex araneus</i>
French shrew	<i>Sorex coronatus</i>
Pygmy shrew	<i>Sorex minutus</i>
Water shrew	<i>Neomys fodiens</i>
Greater white-toothed shrew	<i>Crocidura russula</i>
Lesser white-toothed shrew	<i>Crocidura suaveolens</i>
<i>Rodentia</i>	
Bank vole	<i>Clethrionomys glareolus</i>
Field vole	<i>Microtus agrestis</i>
Orkney and Guernsey vole	<i>Microtus arvalis orcadensis</i> and <i>M. arvalis sarnius</i>
Wood mouse	<i>Apodemus sylvaticus</i>
Yellow-necked mouse	<i>Apodemus flavicollis</i>
Harvest mouse	<i>Micromys minutus</i>
House mouse	<i>Mus domesticus</i>

2.1 Order Insectivora

2.1.1 Common shrew *Sorex araneus*

Population estimate:	UK 41,700,000; England 26,000,000; Scotland 11,500,000; Wales 4,200,000; Northern Ireland 0 (Harris, Morris, Wray & Yalden, 1995).
Legal status:	Bern convention Appendix III; W&C Schedule 6; WMA.
Distribution:	Widely distributed throughout the UK mainland but absent from the Shetlands, Orkneys, Outer Hebrides, Isles of Scilly, the larger islands of the Inner Hebrides, Northern Ireland and the Channel Islands (Churchfield, 1990).
Habitat:	Found abundantly where low vegetation occurs, particularly in rough grass, hedgerows, scrub, deciduous woodland and occasionally in upland heath. They have also been recorded in harvest mouse nests in bushes (Churchfield, 1990).
Density:	Summer peak of 42-69/ha (grassland and deciduous woodland) and lower density of 5-27/ha in the winter (Churchfield, 1990).
Home range:	ca. 370-630m ² (Michielsen, 1966).
Breeding season:	Lasts from April to September, peaking in July and August (Churchfield, 1990).

2.1.1.1 Current surveys

The Mammal Society National Owl Pellet Survey has shown that the common shrew is one of the three main prey species for the barn owl, *Tyto alba*, constituting 19.8% of the prey items recovered between 1993 and 2005 (Love, 2005). This scheme is well established but more sites across the country are needed to ensure that full nationwide coverage is achieved.

2.1.1.2 Past surveys

The Mammal Society National Small Mammal Road Verge Survey (1999-2000) showed that the common shrew constituted 31% of the total catch (live trapping) in the spring and 18% in the autumn. The study also found that the abundance of this species declined rapidly as autumn progressed (Garland, 2002).

2.1.1.3 Survey techniques

2.1.1.3.1 Longworth trapping

Longworth trapping can be used with a tripping weight of 5-6g (Gurnell & Flowerdew, 2006). The traps can be equipped with mouse and vole excluders, ('L'-shaped metal ramps, with a hole in the upright arm, placed between the treadle and the trap door). This will restrict the catch to shrews (13mm hole will catch common shrews). The ramps also help to prevent shrews from becoming caught under the treadle (Michielsen, 1966) and the ramp weight on the treadle enables the tripping weight to be sensitively adjusted (Gurnell & Flowerdew, 2005). A licence is required to carry out Longworth trapping for all species of shrews.

2.1.1.3.2 Pitfall trapping

Churchfield (1990) noted that shrews will readily enter pitfall traps. Shore *et al.* (1995) considered pitfall traps to be an effective long-term monitoring technique for shrews in upland habitats

but less effective than Longworth traps for short-term studies. Their short-term study compared Longworth traps and pitfall traps placed in a grid and found that the overall capture rate for pitfall traps was poor and that 89% of all captures were made in Longworth traps. Shrews were also not recaptured in the pitfalls, suggesting a learned avoidance.

Pitfall traps with a depth of 30cm and diameter of 18cm are recommended to prevent the animal escaping. These traps can be set among ground vegetation in the runs of other small mammals where shrews can often be found. Mounted waterproof covers should be placed over the pitfalls to exclude rainfall and strong sunlight (Churchfield, 1990).

2.1.1.3.3 Hair tubes

Shrews have distinctive cross sections in their hair, and hair tubes, placed at regular intervals or on a grid will detect their presence (Baker *et al.*, 2003). However, more developmental work is needed to distinguish between the hairs of the common and pygmy shrew (Harris & Yalden, 2004).

2.1.1.3.4 Owl pellet analysis

Love *et al.* (2000) found that between 1974 and 1997, there had been a 9.1% decline in the percentage of common shrews found in the barn owl diet. However, these results may have been biased by the changes in owl behaviour regarding prey selection.

2.1.2 French shrew (Millet's shrew) *Sorex coronatus*

Population estimate:	Unknown
Legal status:	Bern convention Appendix III; WMA.
Distribution:	Confined to Jersey (Churchfield, 1990)
Habitat:	Same as for common shrew although species can be found in coastal habitats. Generally, it has an island wide distribution in habitats including heath, scrub and sand dunes as well as hedgerows, gardens and deciduous woodland (Godfrey, 1978a; Magris & Gurnell, 2000).
Density:	Same as for common shrew.
Home range:	Same as for common shrew although it exhibits overlapping ranges with the lesser white-toothed shrew (Magris & Gurnell, 2000).
Breeding season:	Same as for common shrew.

2.1.2.1 Past surveys

A two year survey (1999-2000) was carried out by the States of Jersey Environmental Department (Magris & Gurnell, 2000) to examine the abundance of Jersey's small mammals including the French shrew. Survey methods included Longworth trapping, cat predation questionnaires and owl pellet analysis.

2.1.2.2 Survey techniques

2.1.2.2.1 Longworth trapping

Magris & Gurnell (2000) found that French shrews were rarely caught in Longworth traps and species richness fluctuated according to season and habitat. The study suggests that the French shrew is less widespread and abundant than previously thought. Further investigation was recommended to establish the current status of this species.

2.1.2.2.2 Owl pellet analysis

An owl predation survey (Magris & Gurnell, 2000) found that the French shrew formed 20% of the barn owl diet. This species of shrew was found to be one of the most important prey items (after the bank vole) in terms of calorific content, which may have accounted for its scarcity in the trapping study.

2.1.2.2.3 Cat predation survey

Magris & Gurnell (2000) also undertook a cat predation survey and estimated that the Jersey cat population (ca. 25,500 domestic, 200 feral) kills approximately 289,882 animals annually including lizards, rabbits, squirrels and wood mice. The French shrew constituted 30,259 of this annual catch island-wide. This figure was relatively large in comparison to the lesser white-toothed shrew (13,919). The results indicated the considerable impact of cat predation on this species. The study recommended that cat owners should continue to monitor their pet's hunting activities.

2.1.2.2.4 Vocalisation

See lesser white-toothed shrew.

2.1.3 Pygmy shrew *Sorex minutus*

Population estimate:	UK unknown; England 8,600,000; Scotland 2,300,000; Wales 1,500,000; Northern Ireland unknown (Harris <i>et al.</i> , 1995)
Legal status:	Bern convention Appendix III; W&C Schedule 6; WMA.
Distribution:	Widely found throughout the UK but absent from the Isles of Scilly, Channel Islands and the Shetlands. It is the only shrew species found in Ireland (Churchfield, 1990).
Habitat:	Widespread in all types of habitat with a preference for abundant ground vegetation cover. This species can also be found in aerial vegetation (Churchfield, 1990).
Density:	Maximum summer peak of 12/ha in grassland (Pernetta, 1977).
Home range:	ca. 1400-1700m ² in grassland with increased territories in winter (Pernetta, 1977).
Breeding season:	Lasts from April to October, peaking in June and July (Churchfield, 1990).

2.1.3.1 Past surveys

The ADAS Survey of Small Mammals in Hedgerows (Poulton, 1990) obtained limited data on pygmy shrews in twelve hedgerows in a limited distribution in England and Wales. A total of 174 animals were recorded in all twelve sites and all fourteen seasons of the survey, indicating a low abundance but ubiquitous distribution.

2.1.3.2 Current surveys

The Mammal Society National Owl Pellet Survey has shown that the pygmy shrew is a minor prey species for the barn owl, constituting only 8.9% of the prey items (Love, 2005).

2.1.3.3 Survey techniques

2.1.3.3.1 Longworth trapping

Shrews are readily caught in Longworth traps (Churchfield, 1990) but the use of a treadle ramp and setting of the tripping weight is especially critical for the capture of pygmy shrews. Shore *et al.* (1995) found that a tripping weight of less than 2.5g was appropriate for pygmy shrews. The study suggested that for an upland habitat, a trapping duration of 4-5 days, following 1-2 days of prebaiting, was sufficient to ensure numbers of pygmy shrews active on the grid were captured. This method is similar to those used for trapping shrews on lowland habitats. Trap bait can include blowfly pupae or chopped liver, with hay as bedding. Traps should be checked at least every 8 hours and more frequently in extreme weather. Traps should be positioned on a 7x7 grid at 15m intervals (Macdonald *et al.*, 1998). Mouse and vole 'excluders' will help to restrict the catch to shrews where a 10mm hole will catch pygmy shrews only, although pregnant females may have difficulty (Gurnell and Flowerdew, 2005).

2.1.3.3.2 Hair tubes

See common shrew

2.1.3.3.3 Owl pellet analysis

Love *et al.* (2000) found that the percentage of pygmy shrews found in owl pellets showed an increase of 3.2% between 1974 and 1997.

2.1.4 Water shrew *Neomys fodiens*

Population estimate:	UK 1,169,000; England 1,200,000; Scotland 400,000; Wales 300,000; Northern Ireland 0 (Harris <i>et al.</i> , 1995).
Legal status:	Bern convention Appendix III; W&C Schedule 6; WMA.
Distribution:	Widely found in UK with the exception of Northern Ireland and the Isle of Man. There are localised populations in Scotland (Churchfield, 1990).
Habitat:	Found adjacent to watercourses, generally favouring the banks of fast flowing streams and rivers. They are also found in groups in watercress beds and occasionally hedgerows and woodlands (Churchfield, 1990). Water shrews are inclined to be nomadic during the summer when population and dispersal rates are high (Churchfield, 1984). The lack of a clear definition of the optimal habitat for this species during this season can make the selection of a survey site difficult. Habitat indicators are more apparent during the winter when the population is more stable (Greenwood <i>et al.</i> , 2002). The Mammal Society's Water Shrew Survey will provide detailed information on the habitat occurrence of this species.
Density:	Maximum peak of 3.2/ha in water cress beds (Churchfield, 1984).
Home range:	ca. 20-30m ² on land and 60-80m ² on watercourses (Churchfield, 1990).
Breeding season:	Lasts from April to September, peaking in May and June (Churchfield, 1990).

2.1.4.1 Past Surveys

No nation-wide surveys for this species have been recorded.

2.1.4.2 Current Surveys

The Mammal Society's **Water Shrew Survey** was a national survey which was run over 2 years to determine the distribution and habitat occurrence of water shrews on mainland Britain. Water shrews were found to be present at 18% of more than 2000 sites (Carter & Churchfield, 2006)

2.1.4.3 Survey techniques:

2.1.4.3.1 Baited tubes

Shrews will readily investigate novel objects and will frequently defecate on and inside such objects. The diagnostic remains of aquatic invertebrates (e.g. *Asellus aquaticus*, *Gammarus pulex* and Trichoptera larvae) can be found in the scats of the water shrew. Co-existing terrestrial shrews will rarely feed upon this prey. The prey contained in the scats can be identified using a binocular microscope (Churchfield, Barber & Quinn, 2000). Greenwood *et al.* (2002) used the bait tube method to investigate the distribution and habitat occurrence of water shrews in the Weald of south-east England. Water shrews were found at 42% of survey sites, and were widely distributed in the majority of river catchments and riparian habitats. This successful study was the pilot scheme for future surveys for water shrews.

2.1.4.3.2 Live trapping

Longworth trapping can be used with a tripping weight of 5-6g (Gurnell & Flowerdew, 2005). A 7x7 grid is recommended or a transect of 25 points at 15m intervals with two traps at each point running along a river bank or shoreline (Macdonald *et al.*, 1998). Churchfield *et al.* (2000) considered Longworth trapping to be reliable but expensive, and suggested it should be used as a second option after baited tubes.

2.1.4.3.3 Field sign searches

Faeces can be found in runways through the vegetation, or on rocks adjacent to watercourses and burrow entrances, although these will be very small and hard to find, especially for inexperienced volunteers. Feeding signs include caches of partially eaten snails, amphibia, fish and caddis fly larvae on stream banks or rocks. Faeces are larger than that of the common shrew, and dark when wet, turning a silvery shade when dry due to the remains of aquatic invertebrates. However, this method does not lend itself to a large scale survey as these field signs can be well hidden in vegetation (Churchfield *et al.*, 2000).

2.1.4.3.4 Refugia

Small mammals are attracted to warm and sheltered environments (Sargent & Morris, 2003). This method involves squares of corrugated iron, bitumen or wood which are placed at sites where mammal sightings or droppings have been recorded. The refuge material is unsightly and there is a risk of it being disturbed or moved by humans. However, refugia have a high occupancy rate and the method records both droppings and sheltering animals without the need for bait. Aybes & Sargent (1997) investigated the effectiveness of Longworth traps, feeding tubes and three types of refugia (corrugated iron, bitumen and wooden fibre board) for surveying water shrews. The study showed that metal refugia were most frequently used by water shrews (26% of total records) with the bitumen and wooden sheeting each comprising 21.3% of the positively identified mammal records. The Longworth traps recorded 24.4%. Metal refugia were concluded as the quickest method for recording shrew presence on a site but Longworth traps were considered more effective for recording small mammal species assemblages.

2.1.4.3.5 Owl pellet analysis

Love *et al.* (2000) found that water shrews contributed a small percentage to the barn owl diet between 1974 and 1997. However, this species occurred in barn owl pellets from 66% of sites in 1974 and 65% in 1997. The study also found that the percentage frequency of this species in the

barn owl diet has decreased in all regions since 1974, although the decreases were minimal in south-west and northern England.

2.1.5 Lesser white-toothed shrew *Crocidura suaveolens*

Population estimate:	ca. 40,000 (breeding population) (Temple & Morris, 1997).
Legal status:	Bern convention Appendix III; W&C Schedule 6; WMA.
Distribution:	Only shrew species found on the Isles of Scilly and also on Jersey, Sark, Tresco, Gugh, Samson and Tean (Churchfield, 1990).
Habitat:	Particularly abundant on the sheltered boulder beaches which are common on the Isles of Scilly (Temple & Morris, 1997). In Jersey, they generally occur in coastal habitats including scrub, dunes and heath (Godfrey, 1978b). However, a recent study of the small mammal fauna of Jersey (Magris & Gurnell, 2000) found that the lesser white-toothed shrews were not restricted to the coast.
Density:	One individual per 30m ² has been recorded on the Isles of Scilly, peaking in the summer. Lower densities occur in Jersey where it is in sympatry with the French shrew (Pernetta, 1973).
Home range:	Average 50m ² with maximum of 80m ² . Home ranges vary with males averaging 50m ² and females 27m ² (Spencer-Booth, 1963; Rood, 1965).
Breeding season:	Lasts from March to September (Rood, 1965).

2.1.5.1 Past Surveys

A two year survey (1999-2000) was carried out by the States of Jersey Environmental Department (Magris & Gurnell, 2000) to examine the abundance of Jersey's small mammals. One of the species considered was the lesser white-toothed shrew. Survey methods included Longworth trapping, cat predation questionnaires and owl pellet analysis.

2.1.5.2 Current Surveys

None known.

2.1.5.3 Survey techniques

2.1.5.3.1 Live trapping

A Longworth trapping study (Magris & Gurnell, 2000) showed that this species was present in all of the trap sites including woodland, arable and suburban habitats. It was also found on heath, dune and undisturbed grassland. The metabolic rate of the lesser white-toothed shrew can be 50% lower than that of the genus *Neomys* and *Sorex* (Churchfield, 1990). Consequently, they are less susceptible to trap deaths (Churchfield, 1990) and live trapping could be used to survey this species without causing too much stress to the animal. The island habitats for this species tend to be divided into small patches interspersed with large areas of open space. Consequently, small trapping grids have to be used and the population estimates scaled up to be representative (Temple & Morris, 1997). Harris & Yalden (2004) recommended periodic trapping to determine lesser white-toothed shrew densities in key habitat types.

2.1.5.3.2 Owl pellet analysis

An owl predation survey (Magris & Gurnell, 2000) found that this species formed 3% of the barn owl diet. The survey also revealed that owls with hunting territories >1km from the shore continued to capture lesser white-toothed shrews. This suggested that the prey was distributed further inland than previously thought. No evidence of shrew remains was found in pellets close to the shore, supporting the suggestions from the trapping study that the distribution of this species is not strictly coastal (Magris & Gurnell, 2000).

2.1.5.3.3 Cat predation survey

In their cat predation survey, Magris & Gurnell (2000) found that the lesser white-toothed shrew constituted 13,919 of the annual catch island wide.

2.1.5.3.4 Faecal/bait tubes

Due to this species' association with coastal habitats and its existence as the sole shrew species on the Isles of Scilly, there is some potential for using bait tubes (as for water shrews, see Churchfield *et al.*, 2000). Lesser white-toothed shrews often live under the boulders preying on abundant sandhoppers, *Talitroides dorrieni*, and will retreat to dry land during high tides (Temple & Morris, 1997). Scats can be commonly found among seaweed and under rocks (Magris & Gurnell, 2000). Scat identification will confirm the presence of the lesser white-toothed shrew as there are no other shrew species on the Isles of Scilly.

2.1.5.3.5 Field sign searches

As the lesser white-toothed shrew is the only shrew species found on the Isles of Scilly, there is potential to use bait stations or dropping boards to collect faeces and provide presence/absence and distribution data for this species (Toms *et al.*, 1999).

2.1.5.3.6 Hair tubes

Hair tubes could be used to record shrew presence on the Isles of Scilly as it is the only shrew species on the island.

2.1.5.3.7 Vocalisation

Shrews emit high pitched shrieks and chattering noises, particularly in the summer when they encounter each other (Churchfield, 1986; Magris & Gurnell, 2000). The Channel Islands are popular with visitors and the presence and distribution of island species has been recorded using survey questionnaires to residents and tourists and advertising through the local press (Temple & Morris, 1997). However, shrew calls can be too high-pitched to be heard by older people (Churchfield, 1986) and distinguishing these sounds from other noises such as birdsong may be difficult. It may also be difficult to distinguish calls where two species exist on the island (e.g. French shrew and lesser white-toothed shrew in Jersey). In view of the island exclusivity of these shrews, there may be some potential for their promotion as 'flagship' species which would help encourage awareness and conservation of the species.

2.1.6 Greater white-toothed shrew *Crocidura russula*

Population estimate:	Unknown.
Legal status:	Bern convention Appendix III; WMA.
Distribution:	This species is found exclusively on Alderney, Guernsey and Herm in the Channel Islands (Churchfield, 1990).
Habitat:	Commonly found in grassland, hedgerows and cultivated fields. This species also occurs adjacent to human dwellings and buildings (Churchfield, 1990).
Density:	Unknown on Channel Islands although 77-100/ha have been recorded on the continent (Genoud, 1978).
Home range:	Can range from 75–395m ² (Macdonald & Tattersall, 2001).
Breeding season:	Lasts from February to October in the Channel Islands (Churchfield, 1990; Corbet & Harris, 1991).

2.1.6.1 Past Surveys

The Alderney Wildlife Trust is a small organisation with limited resources. Consequently, they are unable to focus on individual species (Andrews, *pers comm.*).

2.1.6.2 Current Surveys

None known.

2.1.6.3 Survey techniques:

As for common shrew but tailored to habitats, e.g. live traps can be positioned adjacent to buildings and human settlement. Potential survey methods include Longworth trapping, pitfall trapping, owl pellet analysis, faecal tubes, hair tubes and vocalisation.

2.2 Order Rodentia

2.2.1 Bank vole *Clethrionomys glareolus*

Population estimate:	UK 23,000,000; England 17,750,000; Scotland 3,500,000; Wales 1,750,000; Northern Ireland 0, Southern Ireland unknown; 7000 (Skomer vole) (Harris <i>et al.</i> , 1995).
Legal status:	WMA.
Distribution:	Commonly found throughout mainland UK but absent in Northern Ireland. It also occurs on the islands of Ramsey, Wight, Jersey, Skomer, Anglesey, Bute, Mull, Raasay and Handa. This species is also a recent (1950s) introduction to south-west Ireland (Corbet & Harris, 1991).
Habitat:	Found in mature mixed deciduous woodland, particularly where thick field and shrub layers exist. It can also be found in young deciduous woodland, hedgerows and conifer stands. On Skomer, this species occurs in dense areas of bracken and bluebells (Corbet & Harris, 1991).
Density:	Ranging from 12-74/ha in woodland (Corbet & Southern, 1977) but can reach 475/ha on Skomer (Macdonald & Tattersall, 2001)
Home range:	Ranges from 0.05-0.73ha (Macdonald & Tattersall, 2001).
Breeding season:	Lasts from April to October but may vary, sometimes continuing all year round. The Skomer form has a shorter season (May to September) (Corbet & Harris, 1991).

2.2.1.1 Current surveys

The Mammal Society National Owl Pellet Survey has shown that the bank vole is a minor prey species for the barn owl, constituting 5.5% of prey items (Love, 2005).

2.2.1.2 Past surveys

The Mammal Society National Woodland Rodent Survey (1982-1995) co-ordinated approximately 30 surveyors in the UK who live trapped bank voles and wood mice at six-monthly intervals, and, in some of the sites, evaluated the presence of autumn mast crops. The studies provided evidence of population synchrony and the effect of mast crops and local food supplies on population dynamics. However, there were no significant long term trends or annual cycles. The survey concluded that there was some potential in extrapolating population changes from site-specific to national scenarios (Flowerdew *et al.*, 2004).

The Mammal Society National Small Mammal Road Verge Survey (1999-2000) showed that the bank vole constituted 24% of the total catch in the autumn and 18% in the spring. The study found that this species was 2.4 times and 1.9 times more likely to be found in road verges with an adjacent hedge in autumn and spring, respectively (Garland, 2002).

The ADAS Survey of Small Mammals in Hedgerows (1983-1992) involved live-trapping bank voles, common shrews and wood mice (and other species) at two sites in each of six MAFF regions in England and Wales. The surveys were carried out every spring and autumn. The study showed a similarity in seasonal differences of rodent populations to those of the **Woodland Rodent Survey** but, there was a complete lack of synchrony in all of the small mammal species, suggesting the influence of fluctuating food supplies in hedgerows on small mammal abundance (Flowerdew *et al.*, 2004).

2.2.1.3 Survey techniques:

2.2.1.3.1 Live trapping

Longworth traps can be used with 49 traps in a 7x7 grid over 0.81ha. It is advisable to set the grid at least 100m from the woodland edge (Mallorie & Flowerdew, 1994). Hansson & Hoffmeyer (1973) found that the trappability of field voles and bank voles was not affected by using different trap types. Bank voles are frequently caught by placing traps under bushes (Gurnell & Langbein, 1983) and Tattersall & Whitbread (1994) found that 14% of bank vole captures were arboreal, i.e. in the canopy and shrub zones. The study suggested that if a survey for this species is focused solely on ground-based traps, a significant percentage of the population may be missed.

2.2.1.3.2 Owl pellet surveys

Love *et al.* (2000) found that there was increase in the proportion of bank voles (1.5%) in the barn owl diet between 1974 and 1997.

2.2.2 Field vole *Microtus agrestis*

Population estimate:	UK 75,000,000; England 17,500,000; Scotland 41,000,000; Wales 16,500,000; Northern Ireland 0 (Harris <i>et al.</i> , 1995).
Legal status:	WMA.
Distribution:	Commonly found on the UK mainland but is absent from some Inner Hebridean islands (S Rona, Soay, Rhum, Pabay and Colonsay), Shetland and Orkney. It is also absent from the Channel Islands, Lundy, Isle of Man, Isles of Scilly and northern and southern Ireland (Corbet & Harris, 1991).
Habitat:	Prefers rough ungrazed grassland and young forestry plantation with a thick field layer. It will also occur, though in lower densities, in marginal habitats including hedgerows and woodlands as well as moorland and bog (Corbet & Harris, 1991). Bellamy <i>et al.</i> (2000) suggested that the intensification of agriculture and urban development has led to road verges becoming important habitats for small mammals and these areas should be considered as potential survey sites. The study found that the width of road verges in arable areas and the structure of hedgerows had a significant impact on vole numbers. Pollard & Relton (1970) also noted that the field vole will often take refuge in these linear habitats.
Density:	Ranges from 25-250/ha in rough grassland (Lambin, Petty & MacKinnon, 2000), 1-15/ha on mixed farmland (Harris <i>et al.</i> 1995) and 25-45/ha on road verges (Bellamy <i>et al.</i> , 2000).
Home range:	Ranges from 100-1000m ² (Macdonald & Tattersall, 2001).
Breeding season:	Lasts from March to October (Corbet & Harris, 1991).

2.2.2.1 Current Surveys

The Mammal Society National Owl Pellet Survey has confirmed that the field vole is still the main prey species for the barn owl, constituting 43.4% of the prey items. The survey demonstrated that the proportion of field vole remains found accounted for double that of the combined contribution from the other two main prey species (common shrew and wood mouse) (Love, 2005).

2.2.2.2 Past Surveys

Winter Mammal Monitoring Project (2001-2004) (run jointly by The Mammal Society and the British Trust for Ornithology) was a multi-species scheme consisting of two parts. The project involved sightings and signs transect methods. Field voles were seen and identified on only 12 sites (1%) which was considered too few for a dataset analysis. However, 85% of the observers searched a minimum of one transect section for field vole runs and found them on 68% of the sites overall (Noble *et al.*, 2005).

The Mammal Society National Small Mammal Road Verge Survey (1999-2000) showed that the field vole constituted 20% of the total catch in the spring and 10% in the autumn. The study suggested that this species was most likely to be present on verges in the northern and westerly regions of the UK (Garland, 2002).

The Mammal Society Field Vole Survey (1995-1997) involved monitoring unmanaged grassland and a 2-7 year old plantation using Longworth trapping grids. Counts were converted to densities, with 83 voles/ha recorded in the spring and 92-126 voles/ha in the autumn. The survey was brief and inconclusive but emphasised the lack of appropriate survey sites in highly populated areas where there may be a considerable resource of volunteers. The study also demonstrated how monitoring successional habitats such as rough grassland and plantation will give information on how these habitats affect vole abundance rather than show any long-term population trends (Flowerdew *et al.*, 2004).

2.2.2.3 Survey techniques

2.2.2.3.1 Live trapping

Longworth traps can be set in undisturbed grassland with a period of 3-4 days prebaiting. They should be baited with grain, carrots or apple and hay used as bedding (Gurnell & Flowerdew, 2005). However, Redpath, Thirgood & Redpath (1995) found that for upland habitats, live trapping was not an effective method owing to the variance in capture success, even at high vole densities.

2.2.2.3.2 Hair tubes

For field voles in lowland areas there was a far better correlation between runways and vole numbers than either hair-tubes or footprints (Wilkinson, Craze & Harris, 2004).

2.2.2.3.3 Field signs

Hansson (1979) found that feeding signs, runways and faeces piles, correlated well with trap catches of field voles on abandoned fields throughout the year. Field voles leave characteristic piles of oval green droppings in runways and tunnels leading to their underground burrows. They also leave piles of chopped grass at feeding places. Quadrats can be used to record the presence or absence of vole faeces in a given area and will provide a frequency index. The proportion of positive 'vole sign' quadrats can also be calibrated against the data derived from live trapping.

Baited or unbaited faecal dropping boards placed regularly over a large grid can also prove a useful indicator of activity and potentially abundance (Tapper, 1979). However, the faeces of field vole and bank vole can be difficult to differentiate (Toms *et al.*, 1999).

The incidence of vole runs can be used to provide an index of vole abundance and calibrated with actual densities (Tapper, 1976). Voles make surface runways amongst vegetation and the frequency of vole runs can be used as an index for vole abundance. Wilkinson *et al.* (2004) found that for lowland habitats, field signs were the most appropriate monitoring method for surveying field voles. In this type of habitat, runways gave better correlations with field voles than latrines or grass clips. The study further revealed that the technique could detect 25-50% changes in

population levels using just 100 sites, depending on the size of the original field vole population. However, Wheeler (2002) found that fresh grass clippings could be used to produce a reliable index of vole density in upland habitats. The study found that the vole trapping index (VTI) was significantly correlated with the number of survey quadrats with fresh clippings. It was noted that significantly fewer field signs were found in winter. These studies suggest that field sign indices have the potential for being part of a national monitoring scheme. Redpath *et al.* (1995) found that for upland habitats, field signs were an unreliable technique for surveying field voles due to problems in distinguishing between old and new signs in the spring.

2.2.2.3.4 Owl pellet analysis

Field voles are commonly found in the rough grassland habitats frequented by hunting barn owls (Taylor, 1994). Love *et al.* (2000) found that the proportion of field voles in the barn owl diet had not changed since the 1974 survey. The study suggested that this absence of change emphasised the continuing importance of field voles as prey for barn owls in these habitats.

2.2.3 Orkney and Guernsey vole *Microtus arvalis*

Population estimate:	Orkney vole 1,000,000, Guernsey vole unknown (Harris <i>et al.</i> , 1995).
Legal status:	WMA.
Distribution:	The Orkney vole is an endemic subspecies found exclusively in the Orkney Islands. The species occurs on the Orkney Mainland and the islands of Edday, South Ronaldsay, Burray, Rousay, Sanday and Westray. A different subspecies (<i>M. a. sarnius</i>) is found exclusively in Guernsey (Corbet & Harris, 1991).
Habitat:	Orkney voles are found in old peat cuttings, wet heathland, rough grassland, and tall herb vegetation but are unlikely to be found in cereal fields or reseeded grassland. They are often restricted to linear habitats such as fence lines, roadside verges and drainage ditches (Gorman & Reynolds, 1993).
Density:	300-500/ha have been recorded in old peat cuttings, rough grass and linear rough grass habitats (Orkney voles) (Gorman & Reynolds, 1993).
Home range:	Varies from 0.003ha to 0.08ha with a maximum of 0.37ha (Orkney voles) (Macdonald & Tattersall, 2001).
Breeding season:	Lasts from March to November in Orkney although in Guernsey breeding has been recorded as starting in February (Corbet & Harris, 1991).

2.2.3.1 Past Surveys

None known

2.2.3.2 Current Surveys

None current.

2.2.3.3 Survey techniques:

2.2.3.3.1 Live trapping

Wallis (1981) found that trapping along the length of old field boundary dykes resulted in Orkney voles being caught at approximately 3m intervals along the dyke length. The traps were

placed in all the grazed areas along the dyke and at exit holes from the runs. The study also showed that the voles were active within these run systems almost exclusively during the night.

2.2.3.3.2 Owl pellet analysis

Orkney voles serve as an important prey item for hen harriers, *Circus cyaneus*, short-eared owls, *Asio flammeus*, and kestrels, *Falco tinnunculus*. Gorman & Reynolds (1993) found that these birds will synchronise the timing of their hunting with peak vole activity. Prey deliveries were observed from hides and owl pellets were collected opportunistically from nests and the immediate vicinity. The study also found that linear corridor habitats were preferentially hunted by short-eared owls and kestrels.

2.2.3.3.3 Field sign searches

Orkney vole runways are circular tunnels in the vegetation, 3-4cm in diameter which will radiate out from a nest site. The nest sites can often be found underground, adjacent to old fields bordered by dykes or waste heaps of peat cuttings (Wallis, 1981). The animals occupy a single run or tunnel system during the summer and this occupation is an exclusive one. Droppings are cylindrical in shape with a rounded end. They are normally greenish black in colour, approximately 6-7cm in length and 2-3cm thick, and are usually found in piles on vole runs. Feeding piles consist of short sections of neatly cut grass, rush or herb, approximately 2-6cm in length which are piled on the floor of a run (Scottish Natural Heritage, 2005).

2.2.3.3.4 Other methods

A recent rapid decline in hen harrier numbers has been linked to a shortage of Orkney vole prey (Scottish Natural Heritage, 2005). However, Gorman & Reynolds (1993) found the hen harrier was less of a predator of the Orkney vole than the kestrel and short-eared owl. The relatively high degree of diet specialisation exhibited by kestrels and, in particular, short-eared owls, suggested that these bird species were more suitable for the study of hunting habitats with reference to spatial variations in vole density.

2.2.4 Wood mouse *Apodemus sylvaticus*

Population estimate:	UK 38,000,000; England 19,500,000; Scotland 15,000,000; Wales 3,500,000; Northern Ireland unknown (Harris <i>et al.</i> , 1995).
Legal status:	WMA.
Distribution:	Widespread in most areas in the UK with the exception of open mountainous areas. It is absent from the smaller islands including Lundy, Isle of May and the Isles of Scilly (other than Tresco & St Mary's) (Flowerdew, 1984).
Habitat:	Widely distributed in woodlands, field and hedge habitats (Pollard & Relton, 1970). This species occurs widely in both dry and wet areas and may be found independently of deciduous woodland (Montgomery, 1978). In an urban study, Baker <i>et al.</i> (2003) found that wood mice ranged widely in a variety of habitats including woodland, scrub, gardens, churches and allotments.
Density:	Winter peaks and summer/autumn troughs with 1-40 individuals/ha in mixed deciduous woodland (130-200/ha following a good seed crop in the autumn/winter). Low densities occur in arable habitats (0.5/ha in summer and 17.5/ha in winter) (Corbet & Harris, 1991).
Home range:	Ranges from 0.19-0.63/ha in woodland, 0.26-1.77/ha in farmland and 1.58-3.56/ha in sand dunes (Macdonald & Tattersall, 2001).
Breeding season:	Lasts from March until October with sporadic winter breeding (Flowerdew, 1984).

2.2.4.1 Past Surveys

The Mammal Society National Small Mammal Road Verge Survey (1999-2000) showed that the wood mouse constituted 40% of the total catch in the autumn and 24% in the summer. The study suggested that this species was more abundant on verges with dense grassy cover during the autumn (Garland, 2002).

The Mammal Society National Woodland Rodent Survey (1982-1995) showed that there were significant differences in abundance of wood mice in spring and in autumn. Wood mouse numbers were found to almost treble from spring to autumn (Flowerdew *et al.*, 2004).

2.2.4.2 Current Surveys

The Mammal Society National Owl Pellet Survey has shown that the wood mouse is one of the three main prey species for the barn owl, constituting 16.6% of the prey items (Love, 2005). In Ireland, where the field vole and the common shrew are absent, the wood mouse is the primary prey item (Glue, 1974).

2.2.4.3 Survey Techniques

2.2.4.3.1 Live trapping

Longworth traps can be used with 49 traps in a 7x7 grid over 0.81ha. If trapping in woodland, it is advisable to set the grid at least 100m from the woodland edge (Mallorie & Flowerdew, 1994). The widespread occurrence and abundance of this species means that trapping at a small number of sites will not provide an accurate measure of national population trends. Mallorie & Flowerdew (1994) used live trapping over 13 study sites in deciduous woodland. The results of the study suggested that there was a synchrony with the wood mouse relating to tree masting events in this habitat. A large number of sites may need to be sampled across a representative suite of

habitats (Toms *et al.*, 1999). Wood mice are often captured adjacent to logs or at the base of trees (Gurnell & Langbein, 1983). Tattersall & Whitbread (1994) found that 20% of wood mouse captures were arboreal, i.e. in the canopy and shrub zones. Therefore, consideration should be given to the use of arboreal traps to adequately sample the wood mouse populations.

2.2.4.3.2 Hair tubes

Conventional hair analysis (i.e. cross section scale pattern etc.) may not be appropriate for this species as it is difficult to differentiate between the hairs of the yellow-necked mouse and the wood mouse (Toms *et al.*, 1999). However, recent developments in DNA analysis will allow the hairs of the two species to be identified.

2.2.4.3.3 Owl pellet analysis

Love *et al.* (2000) found that the percentage of *Apodemus* spp. (wood mice and yellow-necked mice were not distinguished) in the barn owl showed a large increase (5.5%) between 1974 and 1997. The greatest increase occurred in eastern England where set-aside and arable habitat are particularly common.

2.2.5 Yellow-necked mouse *Apodemus flavicollis*

Population estimate:	UK 750,000; England 662,500; Scotland 0; Wales 87,500; Northern Ireland 0 (Harris <i>et al.</i> , 1995).
Legal status:	WMA.
Distribution:	Largely restricted to woodlands in parts of southern England and the Welsh border (Marsh, 1999) existing in localised, discontinuous populations (Morris, 1993).
Habitat:	Mainly in mature deciduous woodland particularly those adjacent to arable fields (Marsh, 1999) and older coppice compartments (Gurnell, Hicks & Whitbread, 1992). This species prefers drier areas with good canopy and ground cover where fallen trees are regularly used as runways (Montgomery, 1978; Marsh, 1999). It can also be found in marginal habitats including hedgerows, rural gardens and buildings (Corbet & Harris, 1991). This species always lives in sympatry with the wood mouse in areas where both are present (Marsh, 1999).
Density:	Ranges from 1-10/ha but may be up to 50/ha (Macdonald & Tattersall, 2001). Numbers peak late autumn/early winter and decline through the winter and into the spring. There is a variation in accordance with co-existing populations of wood mice, both responding to masting of tree species (Corbet & Harris, 1991; Macdonald & Tattersall, 2001).
Home range:	Extends to 0.5ha for both sexes (Corbet & Harris, 1991).
Breeding season:	Lasts from February to October with occasional winter breeding. This is generally a month earlier than the wood mouse (Corbet & Harris, 1991).

2.2.5.1 Past Surveys

The Mammal Society Yellow-necked Mouse Survey (1998) used Longworth traps to sample small mammal populations from 168 deciduous woodlands during the autumn of 1998. Yellow-necked mice represented 11.3% of the total captures. Wood mice were the most abundant species caught (71.8%) followed by bank voles (13.4%). However, yellow-necked mice were found to be more abundant than wood mice in 15% of sympatric sites. Yellow-necked mice were also found to favour mature deciduous woodland. The study suggested that low summer temperatures would limit the distribution of yellow-necked mice due the impact on tree seed masting and diversity in woodland (Marsh, Poulton & Harris, 2001).

2.2.5.2 *Current Surveys*

None current.

2.2.5.3 *Survey techniques*

2.2.5.3.1 *Live trapping*

Longworth traps can be used with wheat or rolled oats as bait. Traps can be set on grids or transect lines where one trap should be set at ground level and another 1-2m above ground at each point (Macdonald *et al.*, 1998). Both yellow-necked and wood mice are capable climbers (Montgomery, 1980) and Marsh (1999) suggested that yellow-necked mice may be more arboreal than wood mice with an early summer peak in arboreal movement.

2.2.5.3.2 *Hair tubes*

As for wood mice.

2.2.5.3.3 *Owl pellet analysis*

The Mammal Society National Owl Pellet Survey has shown that the yellow-necked mouse is a minor prey species for the barn owl, constituting 0.1% of the prey items (Love, 2005).

2.2.5.3.4 *Dormouse nest box scheme*

See other survey methods

2.2.6 Harvest mouse *Micromys minutus*

Population estimate:	UK 1,425,000; England 1,415,000; Scotland 0; Wales 87,500; Northern Ireland 0 (Harris <i>et al.</i> , 1995).
Legal status:	WMA.
Distribution:	Tends to be biased towards the south-east with isolated populations in the northern counties, southern Scotland and coastal areas of Wales (Corbet & Harris, 1991).
Habitat:	Constructs nests of woven grass leaves above ground level on stalks of vegetation (heights of 30-60cm are common). In low grass the nests will be close to ground level. This species prefers tall, dense vegetation and can be found in rushes, reedbeds, ditches and arable fields (Corbet & Harris, 1991). Harvest mice have been found to have a preference for nesting in wheat rather than barley (Perrow & Jowitt, 1995). Hedgerows or short-term set-aside are not considered favourable habitats for this species (Kotzageorgis & Mason, 1997; Tattersall <i>et al.</i> , 1999). Bence, Stander & Griffiths (2003) suggested that beetle banks and arable field margins, given suitable growth, can support nesting harvest mice. Nests were more clustered in beetle banks (80% of nests within 10m of another) than in field margins (52%). Moore, Askew & Bishop (2003) found that wood mice and especially harvest mice were more abundant in new farm woodlands than in hedgerows, suggesting that new farm woodlands are potentially new habitats for the harvest mouse.
Density:	Ranges from 0.05-0.4/ha in cereal fields and 20-50/ha or more in reedbeds (Macdonald & Tattersall, 2001).
Home range:	Ranging from 300-400m ² (Trout, 1978).
Breeding season:	Lasts from late May until October although will sometimes extend until December dependent upon weather (Perrow & Jowitt, 1995).

2.2.6.1 Past Surveys

Data on this species was collected during the winter 2004 season of **The Mammal Society National Water Shrew Survey**. A total of only 7 volunteers (from 143 who returned information) searched 28 sites for harvest mouse nests. No nests were found although 1 harvest mouse was sighted at one of the sites. Nest counts were also made in the **Winter Mammal Monitoring** period. However, the data collected were too few to be subject to statistical analysis.

A nationwide survey (Harris, 1979) was carried out to establish the status and distribution of the harvest mouse in the UK. Species occurrence was collated on record sheets with 1,205 sheets returned for analysis. The records showed that 66.9% were recorded as nests, 8% in capture mark recapture (CMR) studies and 7.6% as prey items in owl pellets. The study suggested that nest counts are a viable monitoring method to establish harvest mouse distribution (Harris, 1979).

The Mammal Society Harvest Mouse Survey (1996-1997) was a follow-up to the 1979 survey organised through The Society's *Look Out For Mammals* project (Sargent, 1999). 300 of the original 800 sites were resurveyed and harvest mouse nests were found in 29% of these sites. Only 24% of the original sites still had a suitable harvest mouse habitat.

The Harvest Mouse in Cheshire Survey (1999-2000) used nest counts and some live trapping in a small number of sites. Longworth traps were placed on hardboard platforms and secured to bamboo canes. Results showed that 53 harvest mice nests were present at 25 out of 126 sites surveyed (19.8%) while only one (1.9 %) mouse was trapped. The survey also found that fen was the most common habitat for this species in Cheshire (57.4% of total records). In response

to this study, harvest mice were bred at Chester Zoo and re-introduced to 4 sites in Cheshire between 2002 and 2004. Post-release monitoring has included radio-tracking, nest counts and live-trapping (www.cheshire-biodiversity.org.uk, 2005).

2.2.6.2 Current Surveys

None known.

2.2.6.3 Survey Techniques

2.2.6.3.1 Live trapping

Longworth traps can be secured to bamboo canes 0.5-1m above the ground. Harvest mice can be caught on the ground between September and February but they are more readily caught during the summer by setting aerial traps (Macdonald *et al.*, 1998). Perrow & Jordan (1992) designed a lightweight live trap made from a commercially available plastic drainpipe with a wire-mesh (6mm) door and back. Bait (millet, groats or linseed) was added through the back of the trap and retained in position via a plastic bait tray. The trap was attached to bamboo canes and was shown to have the same trapping efficiency as the Longworth trap.

2.2.6.3.2 Hair tubes

Hair tubes (100mm length, 28mm diameter) can be baited with peanut butter and secured to bamboo canes 0.5-1m above the ground (Macdonald *et al.*, 1998). Perrow & Jordan (1992) carried out a small mammal survey in agricultural land using 5,800 hair tubes covering approximately 23ha. The harvest mouse was recorded in all habitats with the exception of grazed grassland. Low densities (<0.5/ha) were recorded in cereals (especially barley) and high densities (>60/ha) were shown in reedbeds and sedgebeds. It may be possible to estimate absolute density with hair tubes if an empirical correlation between the proportion of tubes visited and actual density can be established. Attempts to calibrate hair tube data against live-trapping data indicate that the use of hair tubes is appropriate for this species (Perrow & Jowitt, 1995).

2.2.6.3.3 Nest counts

Harvest mice have characteristic spherical breeding nests which can be used to confirm presence of species (Perrow & Jowitt, 1995). The aerial breeding nests are more obvious in the autumn when the vegetation has died back. Nests are often spatially separated, with 2-3 representing successive litters from one female (Trout, 1978). These nests require strong structural support. Likely vegetation includes Cocksfoot, *Dactylis glomerata* (Bence, Stander & Griffiths, 1999) and reeds and sedges (Harris, 1979; Perrow & Jowitt, 1995). Bence *et al.* (1999) also found that field margins and hedgerow species such as bramble, *Rubus fruticosus*, and thorn, *Crateaegus mongyna* and *Prunus spinosa*, were also utilised as nest sites by harvest mice.

2.2.6.3.4 Artificial baiting nests

Warner & Batt (1976) used tennis balls as artificial baiting nests to attract harvest mice. A hole was made in the wall of the tennis ball before being waterproofed and mounted on a post at a height of 30 to 50cm. The tennis ball was positioned appropriately, baited with bird seed and left for at least five days before being checked to see if the bait had been taken. **The Harvest Mouse Tennis Ball National Survey (1996)** carried out by The Mammal Society covered 13 sites throughout the UK with grids of 50 tennis balls. The study revealed only one of the tennis balls was occupied by a harvest mouse during this period, although nests were found natural vegetation in the same area. However, in the absence of natural vegetation to construct nests, tennis balls may be a useful nest alternative. 'The Aquarium of the Lakes', a project in Cumbria, is currently piloting a captive breeding programme for harvest mice using tennis balls as substitute nests. The scheme is in its early stages but some of the animals have already produced litters in this environment (www.aquariumofthelakes.co.uk, 2005).

2.2.6.3.5 Owl pellet analysis

The Mammal Society National Owl Pellet Survey has shown that the harvest mouse is a minor prey species (2.2%) for the barn owl (Love, 2005). The percentage of harvest mice in the owl's diet fluctuates seasonally but pellets collected between September and March, when the prey proportion is at its highest (Buckley, 1977), may provide valuable supplementary information on species distribution (Glue, 1971). Love *et al.* (2000) found that there was a significant increase in the proportion of harvest mice in the diet of barn owls between 1974 and 1997. In the 1974 study, harvest mice occurred in pellets from all regions, except northern England. In the 1997 survey this species was found in pellets from northern England, southern England, the Midlands and eastern England. In both surveys harvest mice occurred in samples from a disproportionate number of arable sites.

2.2.7 House mouse *Mus domesticus*

Population estimate:	UK 5,192,000; England 4,535,000; Scotland 657,000; Wales 206,000; Northern Ireland unknown (Harris <i>et al.</i> , 1995).
Legal status:	WMA.
Distribution:	Widespread in Britain and Ireland including the majority of inhabited small islands (Corbet & Harris, 1991).
Habitat:	Commonly found in stone walls and natural crevices. In buildings this species will make holes in wooden skirting and doors. In Ireland, they are restricted to buildings on the mainland, but, on offshore islands, open grassland and woodland is the favoured habitat. They tend to avoid open fields, although in north west Scotland and the Hebrides they can be found abundantly on agricultural land (Corbet & Harris, 1991).
Density:	<60/ha (feral island populations); <1/ha (hedgerows and arable fields); 476/ha (piggeries) and up to 70,000/ha in a battery chicken barn (Macdonald & Tattersall, 2001).
Home range:	Up to 100m ² but in buildings house mice will generally range from 3-10m ² . In fields they are often nomadic (Macdonald & Tattersall, 2001).
Breeding season:	Commensal house mice will breed throughout the year. Feral mice will breed from the end of March until September (Corbet & Harris, 1991).

2.2.7.1 Past Surveys

The English House Condition Survey (EHCS), run by the Department for Transport, Local Government and the Regions (DTLR) collected data on this species from approximately 1,200 properties which were surveyed over a 10 week period between April and July 1996 (Langton, Cowan & Meyer, 2001). The overall percentage of dwellings occupied by house mice (infestation rate) was 1.8%, with infestation rates generally higher in rural areas. Infestation rates can be multiplied by the average size of a family group of mice to provide an estimate of population size (Quy, *pers comm.*). An updated House Condition Survey is to be published imminently.

The National Pest Technicians Authority (NPTA) **Annual Rodent Survey (2000-2005)** records the infestation rates of species including *Mus domesticus* annually. The Rodent Surveys are concerned with the brown rat and house mouse. These are questionnaire surveys obtained from 420 regional councils countrywide with an approximate 69% return. The NPTA were willing to supply data from the last five years and recommended contacting local authorities directly to obtain regional figures. Many of the local authorities have now put their pest control work out to external contractors or do not reply to the questionnaires within the time limit (Sheard, *pers comm.*).

However, this data could still be a useful source of additional information in between the EHCS being produced.

Rodent surveys of this nature are of limited value as they do not distinguish between the species of mice caught. Wood mice are also commensal in rural and semi-rural areas (Toms *et al.*, 1999).

2.2.7.2 Current Surveys

The surveys mentioned above are run on an annual basis.

2.2.7.3 Surveys Techniques

2.2.7.3.1 Owl pellet analysis

The Mammal Society National Owl Pellet Survey has shown that the house mouse is a minor prey species (0.9%) for the barn owl (Love, 2005). Love *et al.* (2000) found that the house mouse was seldom recorded in either the 1974 or 1997 surveys and no difference occurred in their presence as prey items at either time. This commensal species is only likely to be recorded as prey to owls which hunt in the proximity of farm buildings. However, the house mouse is considered as the secondary prey item for the barn owl in Ireland and the Isle of Man due the absence of field vole (Glue, 1977).

2.2.7.3.2 Field sign searches

The holes that the house mouse makes are readily distinguishable from those of other commensal species. House mice will often gnaw at man-made structures including doors and food casings, leaving distinctive tooth marks (Twigg & Brown, 1975). However, this would not provide information on the numbers of house mice present in a dwelling.

3 Evaluation of Field Methods

3.1 Introduction

This chapter is divided into sections based on the five main methods, plus a section covering three additional techniques. The first section (live-trapping) is further subdivided into sub-sections covering seven different types of traps. Each of these sections or sub-sections gives a description of the method plus a discussion of the advantages and disadvantages of each.

In addition, the results of a questionnaire survey are included in each section. Wildlife Trusts and Mammal Groups throughout the UK were contacted concerning their views on different monitoring techniques. The following questions were asked:

- What methods have you used and which species have you monitored with each method?
- Please list the advantages and disadvantages of each method?
- Practicality of each method?
 - Volunteer Effort (E.G. How much training to you provide to ensure that volunteers are fully trained to use these methods?)
 - Direct costs associated with each method?
- Do you have any tips on using these methods which might benefit others?
- Any additional comments?

Respondents were both amateurs and professionals with differing degrees of skills and experience and their feedback was recorded in a questionnaire. Of 77 organisations and individuals contacted, 33 questionnaires were returned. The questionnaires were intended to draw upon the experiences of the field worker rather than the organisations they were involved with. It should be noted that although every effort was made to contact these organisations and individuals, a proportion did not return the questionnaires because they either did not have the relevant experience or there were no current small mammal projects running. Longworth traps were the only live trap used by respondents to this survey. The graphs found at the end of each section are calculated from the number of respondents that mentioned using a particular technique and not the total number of respondents. This was thought to give a truer reflection of the relative use of each technique.

3.2 Live trapping

Live trapping offers an effective way to monitor a wide range of small mammal species at one time as many can be found occupying the same habitat. Potential species include wood mice, bank voles, yellow-necked mice, field voles and shrew species. Live trapping enables additional samples (e.g. tissue, blood, ecto-parasites) and biometric data, such as weight and measurements, to be collected. The handling of the animal ensures an accurate identification of species and sex (Ansell, *pers comm.*). Trapping data can show how captures are distributed within a trap grid, potentially revealing microhabitat associations and habitat preferences. Live trapping is also a popular technique among volunteers as it enables them to see and potentially handle species.

However, live trapping is expensive, time-consuming and labour intensive. It can be problematic to sample some small mammal species effectively due to their particular habitat requirements (e.g. harvest mice, yellow-necked mice) (Macdonald *et al.*, 1998). Trapping is considered invasive with the potential to affect population structure through disturbance and trap mortality. Removing animals from their home range and territory could also cause a disruption in the spatial organisation of individuals as well as influencing their movement patterns by providing addi-

tional and temporary food sources (i.e. bait). Live trapping may be unsuitable for use in urban areas where public access may increase the risk from disturbance, theft and vandalism. Losing traps like this is not only costly but will affect the validity of the experiment as well as potentially compromising the welfare of captured animals (Ansell, *pers comm.*).

The success of a trapping study is often dependent upon the skill of the surveyor to identify the species caught and the complexities of the methodology may discourage volunteer participation. Successful trapping is also dependent upon where and how traps are placed on the ground. Less experienced volunteers may overlook important field protocol during the laborious setting and checking of a large amount of traps. Volunteers need some knowledge about the positioning of traps in appropriate microhabitats to ensure the effectiveness of the study. Placing traps next to linear features, runways or burrows can significantly influence the capture rate (Ryan, *pers comm.*). It is worth noting that Redpath *et al.* (1995) found that live trapping was a less satisfactory method than snap trapping when estimating field vole abundance. However, for the purpose of this report, snap trapping is not reviewed as a potential monitoring technique because of the impact it has upon vulnerable species (e.g. harvest mice) and the ethical considerations that surround this technique.

3.2.1 Longworth trap

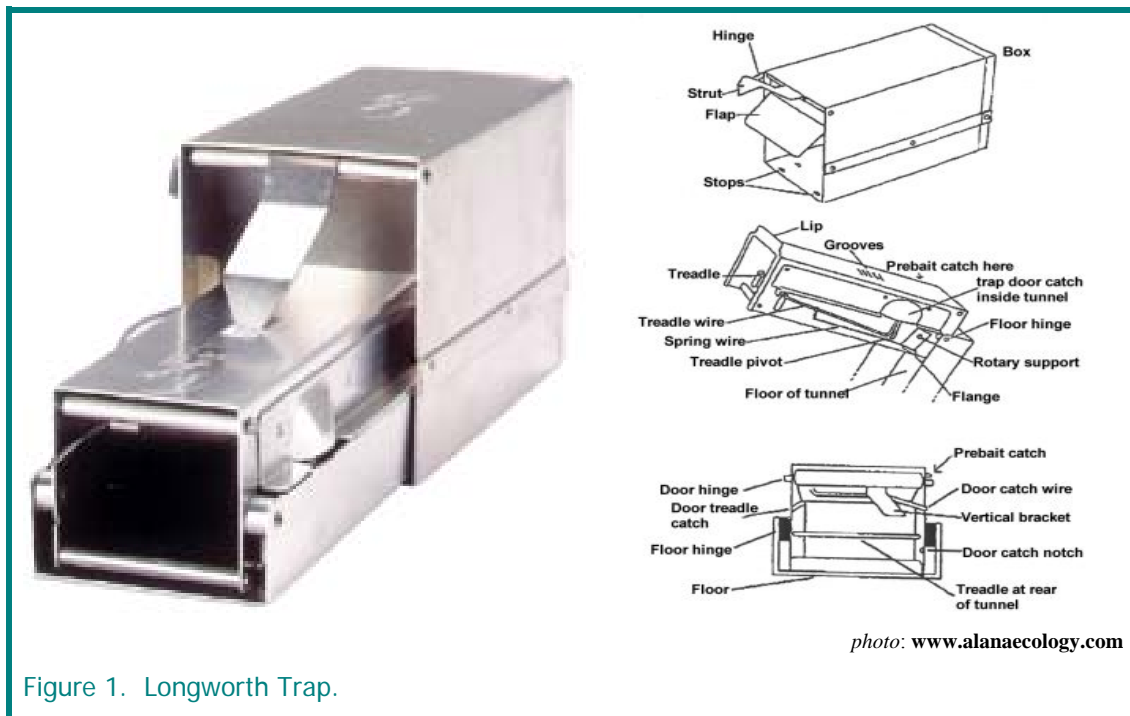

The Longworth trap is an aluminium box-trap, widely used in the UK for small mammal surveys (Flowerdew, 2004). The trap is comprised of two sections; a tunnel and a nest box. The tunnel section is pushed into the nest box and can be pulled back to fit into place. The sections can be disengaged to extract the catch from the nest box (Gurnell & Flowerdew, 2005). Traps cost £35.51 each (plus VAT & carriage) with a minimum order value of £50. They are available from Penlon Ltd. (www.penlon.com). A trap loan scheme is run by The Mammal Society which enables members of The Society to hire up to 50 traps (subject to availability) over several weeks. There is no charge for the use of the traps other than dispatch and £50 returnable deposit.

3.2.1.1 Advantages of the Longworth trap

The Longworth trap is lightweight (<250g) and sensitive (treadle weights can be set at 2g). Pre-baiting is easily carried out and treadle ramps can be attached (Flowerdew *et al.*, 2004). These

traps can be used for small mammals of different sizes (especially shrews) as the tripping weight can be easily adjusted (Little & Gurnell, 1989). The large nest box provides ample space for food and bedding which is essential in temperate climates. This nest box can be positioned at an upward angle relative to the tunnel section, ensuring any condensation, rainfall or urine will drain from the trap. The two-section trap design enables easy access to parts for cleaning and the tunnel can be pushed inside the nest box for ease of transport and storage. Spares are also readily available from manufacturers for quick repair. Longworth traps, unlike Sherman traps, are equipped with a mechanism which locks the trap door open to allow prebaiting (Gurnell & Flowerdew, 1990).

3.2.1.2 Disadvantages of the Longworth trap

Longworth traps have been found to be less effective for random sampling all members of a small mammal population than pitfall traps (Boonstra & Krebs, 1978). Larger individuals such as voles are able to spring traps without being captured and can, consequently, be underrepresented in long-term population studies. These animals catch the closing door of the trap and back out, leading individuals to become more 'trap-shy' (Boonstra & Rodd, 1982). However, Slade, Eifler, Gruenhagen & Davelos (1993) found that lengthening the treadles prevented voles retreating from the trap. Voles have also been shown to chew at the free edges of Longworth traps to facilitate escape and may also gnaw the door bracket free from the inside once captured. Smaller pygmy shrews may also be under-represented in a small mammal population as they may not be heavy enough to activate the treadle mechanism (Gurnell & Flowerdew, 1990).

The diameter of the tunnel is relatively small (50x62mm) and consequently Sherman traps may be preferred over Longworth traps because the size of the entrance is larger (Morris, 1968). Longworth traps are only manufactured in one size which tends to limit capture weights to less than 70g (Gurnell & Flowerdew, 2005). However, this should not be a significant problem when sampling UK small mammal species. The expense of the Longworth trap can constrain the study design (Lambin & Mackinnon, 1997) and they are designed to catch only one individual at a time, which can lead to trap saturation when the density of animals is high and trap numbers are low (Andrzejewski, Bujalska, Ryszkowski & Ustyniuk, 1966). The trap can be over-sensitive and is liable to be activated by slugs or tripped through the ground vibrations of passing mammals such as rabbits (Morris, 1968). Some volunteers will require training to use Longworth traps and a licence is needed to trap shrews.

3.2.2 Sherman trap

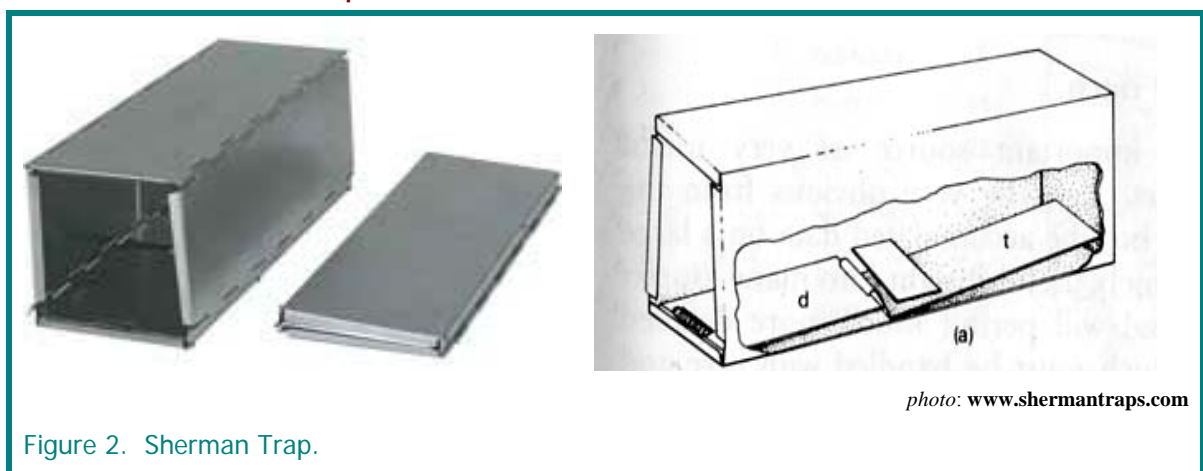

Figure 2. Sherman Trap.

The Sherman trap is an aluminium box-trap, commonly used in the United States. It has a door at one end leading to a weight sensitive treadle at the other. The door is locked open in the field

by applying the spring clamp to the door mechanism or by bending the treadle trigger. As the small mammal walks onto the weight-sensitive treadle, it releases the spring-loaded door which closes behind the animal. Traps come in various sizes with costs ranging from £13.75 to £24.50 (inc. VAT). They are available from Alana Ecology Ltd. (www.alanaecology.com).

3.2.2.1 Advantages of the Sherman trap

The Sherman trap is manufactured in various sizes for small mammals as collapsible or fixed-sided models. Extended versions have been designed to capture larger or long-tailed small mammals (Slade *et al.*, 1993). The trap is light (ca. 250g) and can be folded into a thickness of approximately 15mm for easy transport. This makes them particularly useful for when equipment has to be carried across different sites. The Sherman trap is also easier to clean than the Longworth trap.

3.2.2.2 Disadvantages of the Sherman trap

The Sherman trap is expensive, although not as costly as the Longworth trap. When the spring loaded door activates on the upswing it can potentially skin or sever the tail of the animal. The trap needs to be cleaned frequently to remove grain and bedding to prevent it from lodging under the treadle plate. Re-assembling can be time-consuming and the collapsible models may distort over time or become jammed if not maintained (Twigg, 1975). They are also prone to collapsing in the field (Barnett & Dutton, 1995). The constant bending back and forth of the treadle trigger when setting for capture can lead to metal fatigue, ultimately undermining the sensitivity of the trap (Gurnell & Flowerdew, 1990). Ventilation is relatively poor and moisture can easily accumulate within the trap (Barnett & Dutton, 1995). As is the case for most single-capture live traps, once triggered (regardless whether a species is captured), it is rendered ineffective as part of the study effort (Aplin *et al.*, 2003). A study by Morris (1968) showed that an equal number of species were caught using Sherman and Longworth traps singly placed at trap stations. However, more captures were made in the Sherman traps when the two different trap types were set alongside each other at trap stations. Sherman traps are not effective for capturing small shrews. It is difficult to place sufficient food and bedding in the traps without interfering with the mechanism and the smallest of shrews can become trapped and sometimes perish under the treadle (Churchfield, 1990).

3.2.3 Ugglan trap

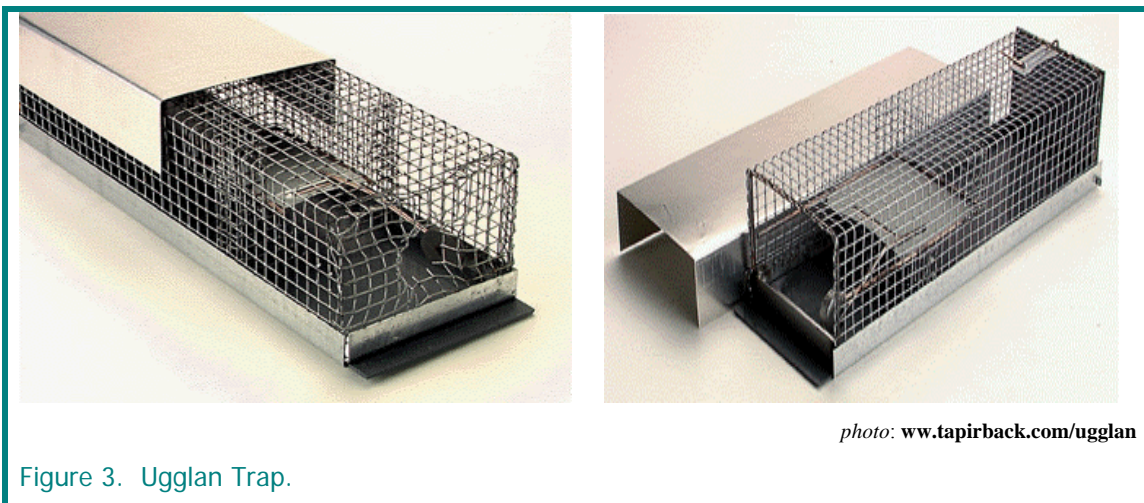

Figure 3. Ugglan Trap.

The Ugglan trap is a rectangular cage trap developed in Sweden in the 1970s (Hansson & Hoffmeyer, 1973). They are widely used in small mammal studies in Europe, in particular Scandina-

via (Lambin & Mackinnon, 1997; Jacob, Ylönen & Hodkinson, 2002). They are manufactured and exported by Grahnab (www.grahnab.se).

3.2.3.1 Advantages of the Ugglan trap

The trap is gravity-controlled not spring-loaded (as Sherman and Longworth traps are), therefore the mechanism is not subject to accidental activation and it enables a multiple catch. Unlike the Sherman trap, the treadle is elevated above the floor of the trap which prevents the plate becoming fouled and jammed with animal faeces. The trapping mechanism can be triggered by weights as low as 5g and requires little maintenance (Lambin & Mackinnon, 1997). The catch cage provides good ventilation and there is sufficient space to ensure the mammals are comfortable during captivity. The trap is small and light enabling easy transport (Jacob *et al.*, 2002). There are three different models, each designed to catch a specific range of small mammal. Each model is 250 x 78 x 65mm in length. One trap is used for small mice and shrews (equipped with an entrance net to prevent larger mammal intrusion). The second model has an open entrance without a net and the third model is used for trapping larger mammals such as voles (www.tapirback.com, 2005). Lambin & Mackinnon (1997) found no evidence that Longworth and Ugglan Mouse Special traps differed in their ability to capture field voles. The total captures for each trap type were of a similar age and sex ratio. The Lambin and Mackinnon study also shows that Longworth traps are more durable than Ugglan traps. The study considered the cost difference (ca. £29) and suggested that the Ugglan trap offered an effective and cheaper alternative to the Longworth traps. Although shrews were not the subject for this study, it was noted that throughout the trapping period 2-3 times more shrews (*Sorex araneus* and *S. minutus*) were captured in Ugglan traps than in Longworths.

3.2.3.2 Disadvantages of the Ugglan trap

Jacob *et al.* (2002) found Ugglan traps to be less efficient than Longworth traps for capturing house mice (32 and 122 captures, respectively). The study suggested this was due to the reluctance of the animal to activate the gravity-led trapping mechanism. There was a high mortality rate in the mice using Ugglan traps which was attributed to the exposed sides of this trap, suggesting that this trap would be less effective for studies in colder climates. It was expected that Ugglan traps would yield multi-captures and overcome the problems of trap saturation in high density small mammal populations. The study concluded that this was not the case and these traps had a low trappability and recapture rate. Lambin & Mackinnon (1997) noted that although the Ugglan Mouse Special traps were not effective for trapping larger rodents, using other Ugglan models may be more successful. If multiple individuals/species are caught in Ugglan traps they will often die through fighting with each other.

3.2.4 Trip-Trap



The ‘Trip-Trap’ is an all-plastic transparent trap similar in design to the Longworth trap. Traps cost £10.26 each (plus VAT & carriage) with a minimum order value of £50. They are available from Penlon Ltd. (www.penlon.com).

3.2.4.1 Advantages of the Trip-Trap

The ‘Trip-Trap’ provides the ideal solution for short-term or occasional use, or for larger surveys where cost may be an issue. It offers a good method for catching small mammals for basic inventory studies and offers a cheaper and lighter (<200g) alternative to the Longworth trap. Like the Longworth trap, the tunnel section can be removed and stored inside the nest box for good portability (Gurnell & Flowerdew, 1990). As the ‘Trip-Trap’ is transparent, any captive can be inspected easily without actually handling it which will minimise any animal stress. The animal’s location within the trap can easily be determined and, in some cases, the species and sex identified. For this reason these traps may be useful for demonstration/training purposes. Roscrow (2005) suggested that the ‘Trip-Trap’ was less conspicuous to the animals in the field than the Longworth trap, especially on moon-lit nights when animal activity can be high. The ‘Trip-Trap’ showed a higher than expected capture rate during a full moon. This was attributed to the aluminium Longworth trap reflecting the moonlight whereas the opaque brown plastic ‘Trip-Trap’ did not.

3.2.4.2 Disadvantages of the Trip-Trap

The main drawback of this trap is their lack of robustness; they can be rendered irreparable if stepped upon in the field (Roscrow, 2005). The plastic casing has a tendency to crack and the captured animals can chew through and fracture the trap. Captives may also scratch frantically at the interior trying to escape, consequently rendering the casing opaque. Roscrow (2005) considered the ‘Trip-Trap’ highly unreliable in different climatic conditions. In a wet or humid environment, the door was kept open by the water tension created between the door and tunnel roof (slug slime was found to have similar effects). Roscrow (2005) also found that the ‘Trip Trap’ was difficult to clean in the field as unlike the Longworth trap, the tunnel section cannot be flipped open. Trap design did not enable pre-baiting and the sensitivity of the treadle weight could not be adjusted, and therefore shrews were not eliminated from the study. Gurnell & Flowerdew (1990) recommended using enough traps to have one drying indoors to replace the

wet traps in the field. The ‘Trip-Trap’ is sold in hardware shops as a humane trap for house mice and there may be potential for using this device a monitoring tool for indoor species.

3.2.5 Wellfield trap

The Wellfield trap is an aluminium box trap consisting of a base tray, a nest box with a rear door with a snap catch (available with a shrew escape hole) and an entrance tunnel. Traps costs from £34.95 (inc. VAT). They are not currently commercially available but their manufacture will be resumed in 2006. Supplier contact is Alana Ecology Ltd. (www.alanaecology.com).

3.2.5.1 Advantages

The Wellfield trap is cheaper and slightly smaller than the Longworth trap. It also has a rear access door where the catch can be retrieved.

3.2.5.2 Disadvantages

Trap sensitivity is preset and cannot be adjusted for this model. The nest box cannot be angled and therefore moisture can accumulate inside the traps.

3.2.6 Havahart trap

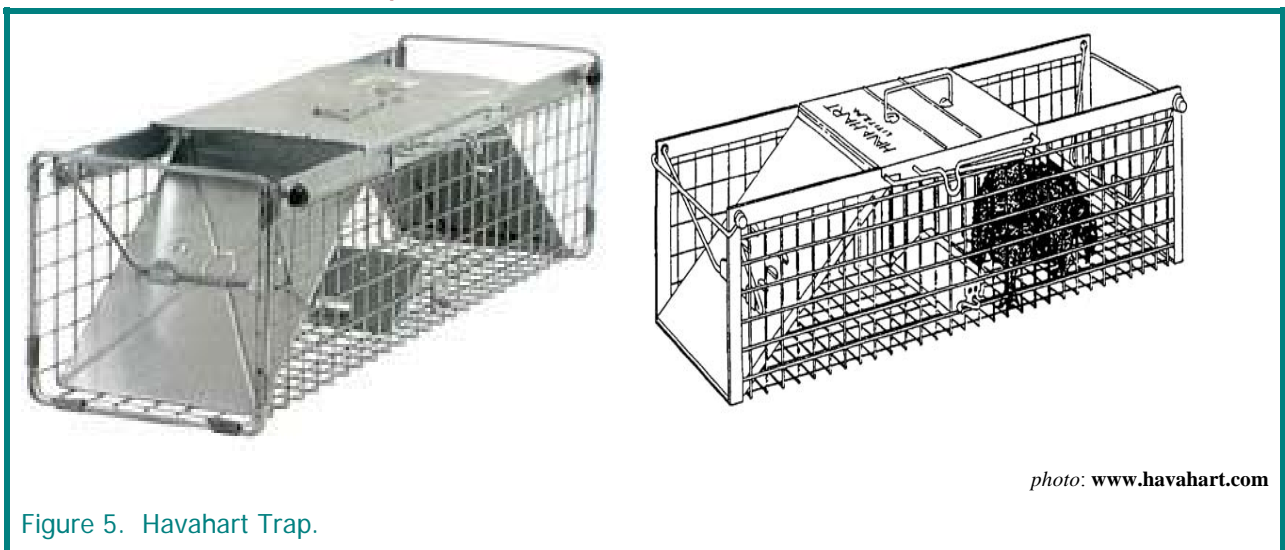

Havahart traps are wire mesh cage traps mainly used in North America. They have doors at both ends of the tunnel, operated jointly by a central gravity-controlled treadle. Weight on the treadle releases the struts holding the doors open with re-opening prevented by a simple locking device. The traps cost approximately £8.33 each and can be purchased online at www.havahart.com.

3.2.6.1 Advantages of the Havahart trap

The Havahart trap opens at both ends where the intention is to deceive the more cautious species into thinking they may escape through the trap (www.havahart.com, 2005). The wire mesh construction is manufactured at little cost and enables light and easy use. Several sizes are available and the smallest size (door opening of 76x76mm) is considered suitable for small mammals (Delany, 1974).

3.2.6.2 Disadvantages of the Havahart trap

The catch can be clearly seen without opening the trap so the captive may be harassed by predators as they try to gain access to the catch. There is little space for food or bedding and, therefore, little insulation in colder climates (Gurnell & Flowerdew, 1990). The tripping apparatus is also considered over-sensitive and can be triggered by heavy rainfall (Delany, 1974).

3.2.7 Pitfall trap



Figure 6. Pitfall Trap.

These are containers sunk into the ground where animals will fall and become trapped. The traps can be constructed from readily available materials such as tin cans or plastic buckets (Jones *et al.*, 1996). In the UK they are generally used in remote upland areas due to their ease of use and effectiveness (Macdonald *et al.*, 1998).

3.2.7.1 Advantages of the pitfall trap

Pitfall traps are used for sampling animal populations by capturing species which may be difficult to obtain by other methods. Body size will determine a species' susceptibility to these traps, where the smallest individuals and less acrobatic species are caught (Aplin *et al.*, 2003). Mad-dock (1992) found that small mammals weighing between 5 and 25g were readily caught in pit-fall traps, whereas larger animals (30-60g) were more commonly caught in box traps. This makes pitfall traps ideal devices to capture shrews and voles (Brown, 1969; McManus & Nellis, 1972; Hice & Schmidly, 2002; Powell & Proulx, 2003). Pitfall trapping takes advantage of the drifting behaviour of small mammals and permanent trap sites can be set up for long-term monitoring. Pitfall traps, unlike box traps, are non-selective and can produce a high rate of multiple captures (Southwood, 2000). They will also catch a greater diversity of small mammals than other live traps and the extra effort needed to place these traps is compensated by their low maintenance (Williams & Braun, 1983; Catling, Burt & Kooyman, 1997).

3.2.7.2 Disadvantages of the Pitfall trap

Pitfall traps can be labour and time intensive particularly when large numbers need to be installed. The positioning of the traps has to be changed over time as the runs of small mammals will change (Churchfield, 1990) and shrews tend to avoid the traps after first exposure (Twigg, 1975; Macdonald *et al.*, 1998). Andrzejewski & Rajska (1972) found the traps were ineffective for catching rodents and Pucek (1969) suggested that pitfall traps were not as efficient as box traps for catching rodents. However, Williams & Braun (1983) found that rodents and insectivores could be trapped if the trap design was well considered. McCay *et al.* (1998) suggested the

disruption of the animals' movement patterns caused by the drift nets may cause certain species to be under or over estimated. Pitfalls are also impractical where the ground is low-lying as they may become waterlogged and the traps may fill up with water, potentially drowning the specimen. The traps are also not easily moved around the site compared with other live traps and require deactivating when they are no longer in use. There is a potential for capturing non-target species and animals trapped together may kill each other. The trapped animals will also make easy prey for larger predators. Unbaited traps need regular checking as the captive is deprived of food and water. The traps can be closed off with lids and re-opened at a later date (www.animalethics.org.au, 2005). However, Shore *et al.* (1995) found that closed pitfall traps do not compare well with pre-baited Longworth traps in the field. The study suggested the animals may lose familiarity with the pitfalls when closed and preferentially use the pre-baited Longworths because of the trap association with food.

3.2.8 Questionnaire Survey Results

3.2.8.1 *Advantages of live trapping*

Several respondents considered that live trapping collected more complete data than any other survey method. The capture of the animal allowed the species to be easily identified and the sex, age, and breeding condition of the individuals recorded. Many respondents found that this method was easily repeatable at single and multiple sites and it allowed coverage of a range of species including common shrew, pygmy shrew, bank vole, field vole and wood mouse. It was also noted that live trapping enabled easily calculable population and density estimates through CMR techniques. Several respondents thought that live trapping could generate accurate results from long-term constant effort sites. Live trapping was generally considered a harmless technique where the handling of the catch ensured volunteer interest was sustained throughout the study. Longworth traps were found to be sturdy, durable and easy to clean in the field. The traps were also relatively independent of climatic fluctuations and the adjustable treadle weight was useful to eliminate shrews from a study.

3.2.8.2 *Disadvantages of live trapping*

The majority of respondents thought that Longworth traps were an expensive option for surveying small mammals. Consequently, it was difficult to obtain sufficient traps to undertake a thorough study. Some noted that trapping sessions could be time consuming to set up, monitor and maintain over several nights with a twice daily check. Several respondents felt that the theft, vandalism and/or disturbance of traps placed in public areas were a concern in terms of study validity and the cost of replacing traps. Some thought that the continual maintenance of traps with moving parts was a distinct drawback. The necessity for a shrew licence was also considered a disadvantage. The association of bait as 'free food' was found to attract 'trap-happy' species and one respondent noted that Longworth traps were too easily tripped and not effective for trap-shy species such as field voles. Several respondents thought that pre-baiting caused a strain on the work force by lengthening the survey time. Some found that harvest mice and pygmy shrews were too light to trigger the traps. One respondent found the traps were not suitable for harvest mice in summer as this species does not often occur at ground level during this time. There was also a risk of trap deaths (especially shrews) if the animals were left in captivity for too long, with insufficient food or cover, particularly in extreme weather. Some suggested that there was a risk of bites from handling the catch and good training and supervision was essential during the initial trapping sessions. One respondent considered shrew holes in Longworth traps to be a bad idea as small and juvenile animals may become trapped and perish while trying to escape. Also, the effective number of animals caught will be reduced due to the small/immature animals escaping through these holes. One respondent noted that Longworth traps were bulky

and heavy when putting out in large numbers. They also found that slugs tended to trigger traps in woodland during the summer. Finally, it was suggested that without prior knowledge of the magnitude of inter-annual fluctuations of a particular species it is difficult to predict the numbers of traps needed at trapping points to prevent saturation.

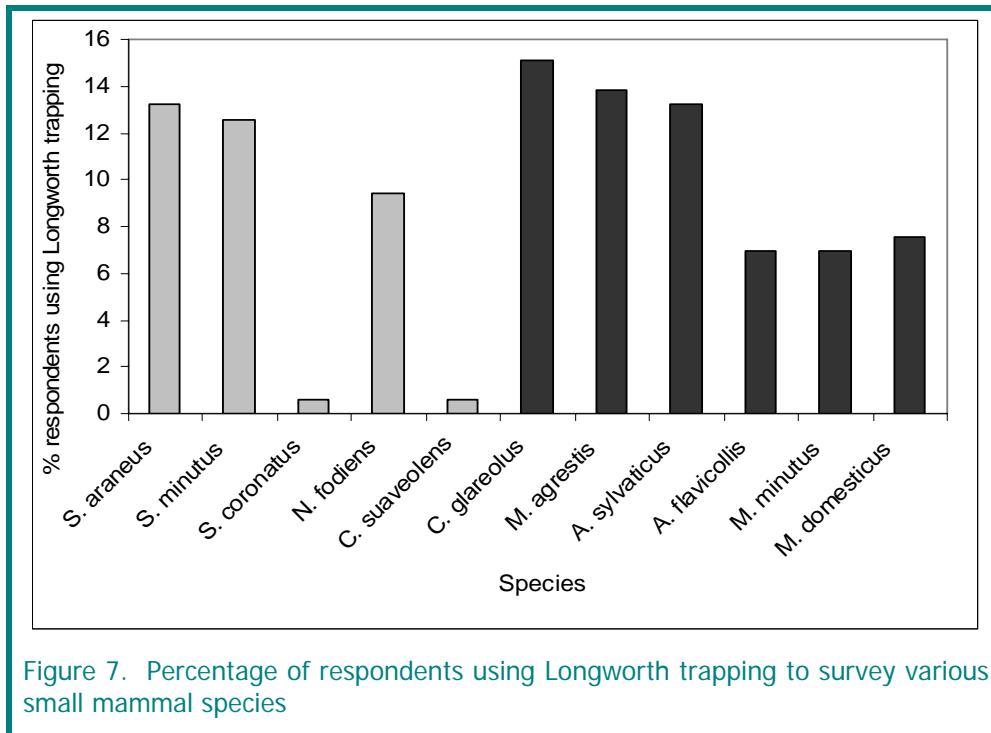

3.2.8.3 Volunteer Effort and Training

The majority of respondents found that Longworth trapping required high volunteer effort, i.e. 1-2 days of training. An initial period of supervision was required until it was felt that the volunteers could manage their own trapping and recording projects. One surveyor pointed out the necessity of a shrew licence when live trapping as this species is likely to be encountered during a survey. Training needs to include health and safety, species identification, welfare protocols, site visits and installation of the survey apparatus. Most respondents thought the majority of the training should be focused on the checking/handling of captures and ensuring the welfare of the animal. It is worth noting that many of the respondents took part in the *Winter Mammal Monitoring Project* and have already undertaken small mammal survey and ecology training through The Mammal Society.

3.2.8.4 Direct Costs

Most respondents considered the initial purchase of Longworth traps to be the biggest expenditure especially as large numbers of traps were required to effectively calculate population trends. One respondent felt a minimum of 20 traps was necessary for a demonstration and 50 or more for a professional study (not including spares). Bait (especially casters) and bedding (e.g. hay, cotton), were considered as ongoing costs. Labour and transport to the sites were also mentioned as peripheral expenses. It was noted that travel costs may mount up if a field worker lives some distance from the trapping site. Twice daily visits over a survey period of 4-5 days (longer if prebaiting) proved expensive. Some respondents pointed out that weighing scales and scissors were essential to record biometric data, resulting in extra expense. Another used The Mammal Society trap loan scheme which involved the costly return posting of heavy traps. However, this

cost was considerably less than actually buying the traps. One respondent mentioned that there is some cost involved in maintenance and repair of traps.

3.2.8.5 Additional Comments

Some respondents recommended looking for runs and other field signs in vegetation while placing the traps. It was suggested that placing traps near to the pre-bait was effective. Some considered that traps should be positioned near log piles or scrub and public areas and footpaths should be avoided to ensure traps are safe from disturbance or theft. However, reasonable access to the trapping site was considered important to enable the transport of trapping equipment. Trapping near roads was not recommended and required additional safety precautions. One respondent noted that Wellfield traps were cheaper than Longworth traps and just as efficient. Another mentioned that when live trapping, the field worker should be aware of local variation in population density in woodlands. It was suggested that several trapping grids should be placed in the habitat to account for this.

Carrots were recommended as additional bait for field voles especially in hot weather to provide extra hydration. Peanut butter was considered a good attractant for rodents (especially wood mice but not for field voles). A recommended bait mixture was wheat, peanuts, sunflower seeds, a piece of carrot and blowfly pupae (for the shrews). To help locate traps in the field, it was suggested a piece of white electrical tape could be attached to vegetation at the beginning and end of each row. This was considered to be conspicuous only to the field worker. Knotting together a few heads of grass above the trap to mark the trap position was another suggestion. Another respondent had used bamboo canes sprayed with fluorescent paint to locate each trap station. If there is public access to the site these markers will need to be more subtle. One respondent found that rolling the hay bedding into a ball before placing inside the trap ensured that the bedding did not protrude and take up external moisture. Covering traps with vegetation was suggested to keep them hidden from view and to ensure the captive animals are cool/warm during hot/cold weather, respectively.

One respondent recommended keeping a thermal hat or glove to hand when emptying traps to revive any animals that may have become wet and cold during captivity. It was considered important to check with land owners regarding any planned maintenance work on the survey site as traps may get caught up in agricultural machinery. Permission for trapping should be sought and landowners made aware of the trapping dates. When setting a trap, it was felt that it should be double-checked to ensure the trap works and is not obstructed by bedding or bait. Most of the respondents considered it essential to place plenty of food in the traps and that the animals should not be left in the traps for long periods. Pre-baiting was thought to give a good response rate for live trapping. One respondent felt that as it was often dark when setting the traps at night, it was important to have two people present and a torch.

3.3 Owl pellet analysis



Figure 8. Pellets and separated small mammal prey remains

Small mammals, in particular the field vole, constitute a large part of the barn owl (*Tyto alba*) diet in the UK (Glue, 1967; Love *et al.*, 2000). The bones, teeth, claws and fur of the small mammal prey cannot be digested by the barn owl and are consequently regurgitated as a pellet, consisting of the skeletal remains of the prey, tightly packed in a fur matrix. A barn owl will cast an average of two pellets per day. The pellets can be collected from a survey site and the source of each pellet batch and time period covered recorded. The skeletal remains in the pellet are separated from the fur by dissolving the matrix in a solution of sodium hydroxide (NaOH). The skulls and jawbones of the small mammals can then be identified to species level (Love, 2005).

The diet of barn owls reflects the relative abundance of small mammal prey species in the environment. As such, owl pellet analysis is a useful tool for detecting changes in the abundance of various prey species (Love *et al.*, 2000). The barn owl is widely distributed throughout the UK and Ireland (Love, 2005) and owl pellet material is valuable in revealing the local presence of a range of small mammals which constitute a large part of their diet.

For owl pellet analysis two types of volunteer are required; collectors and analysers. Collectors need to carry out a basic habitat assessment and be able to read grid references. Site access for pellet collection also needs to be negotiated with landowners and/or land managers. Glue (1971) recommended collecting pellets near barns and derelict buildings as these are preferred artificial sites for barn owls and will generally outnumber natural nest sites. Analysers are involved in the recovery of skeletal material from the pellet. This can be done using a dissection kit but the use of NaOH is accepted as more effective. The success of owl pellet surveys is reliant upon volunteers collecting and sending pellet batches to the project co-ordinator for analysis on a regular basis (Love, *pers comm.*).

The barn owl seldom decapitates the prey with the result that the pellets contain a good skeletal record of the small mammal caught (Glue, 1971). A wide range of species can be covered, in particular the field vole, wood mouse and common shrew, which collectively provide the majority of the prey items in barn owl pellets. Owl pellet analysis can show the proportions of the prey items provided by the various prey species indicating the availability of the prey species to the owl. This method can also demonstrate annual and seasonal variation in the contribution from the main prey species, giving a greater understanding of the population dynamics of small mammals.

Large sample sizes can be easily obtained, and, with some training, small mammal species can be easily identified and abundance estimated using skulls and teeth found in the pellets. The use of NaOH to separate the skeletal material from the fur matrix enables the efficient processing of batches (ca. 16 pellets per session). The pellets can be easily found in the field and pellet searches are relatively non-invasive providing volunteers with the opportunity to develop their field skills. Collectors do not need much skill or specialist equipment and pellet collection can be spread over time by making routine site visits (e.g. every 2 months). Analysers require no specialist equipment although a x10 microscope can be useful to aid species identification from the skeletal remains (Love, *pers comm.*).

3.3.1 Disadvantages of owl pellet analysis

Owl pellet surveys are dependent on a large proportion of the prey items being present in a pellet batch (Love, *pers comm.*). Barn owls are primarily nocturnal and the majority of small mammal prey will be taken during this period (Barnett & Dutton, 1995). As most small mammals are active both night and day the populations may be under-represented as a whole by using owl pellet analysis as the predominant field method.

As the habitat requirements of species differ, their relative proportions in owl pellets will be influenced by the habitats present within the owl territories. Providing, however, that there are no major changes in habitat, relative proportions should not be influenced. Species which inhabit woodland may, however, be underrepresented. Indeed, Torre *et al.* (2004) found that owl pellets were found to have over-sampled insectivores and grassland rodents and under-sampled woodland and arboreal rodents. The study suggests that this was due to the barn owl's association with open habitats in contrast to the wooded areas which were less frequented by this species.

Geographical location will also dictate the value of this technique. Where field voles and common shrews are absent, as is the case with the Isle of Man and in Northern Ireland, barn owls will prey upon wood mice and brown rats primarily with pygmy shrews and house mice as the secondary prey (Glue, 1971).

Another problem with this survey method is that the prey species for the barn owl may alter over time (Love *et al.*, 2000). The relative proportions of the main prey species vary seasonally, and, therefore, to ensure valid direct comparison of the samples from different sites, the total pellet batch from each site must cover the same period (Love, *pers comm.*). The barn owl is an optimal forager (Glue, 1967) and tends to deliver the larger, more profitable prey items to their chicks, keeping smaller prey for themselves. This has important implications if pellets are to be collected at a nest (chick) or roost (male) site. The barn owl diet has a large bias towards voles (particularly field voles) and does not, therefore, represent the total prey populations found within the birds foraging areas (Askew, *pers comm.*). Shawyer (1996) found that the foraging range of the barn owl was typically 1km during the breeding season and 3km in the winter. Askew (*pers comm.*) has recently observed owls up to 2.5km from their nest site although 97% of observations were within 2km. These wide foraging areas make it hard to determine the exact location of the small mammal prey and the location of the nest or roost site where the pellets are collected is unlikely to be that from which the prey were caught.

3.3.2 Other owl species

The tawny owl, *Strix aluco*, frequents closed habitats, e.g. woodland, copses and urban areas and their pellets can provide a useful complement to barn owl pellets (Glue, 1970). However, pellets from owl species other than barn owls can be difficult to find in quantity (Love, *pers comm.*). Collecting tawny owl pellets in quantity can be difficult due to the roosting height of this species. Southern & Lowe (1982) found that falling pellets from this species will often be dispersed or fragmented and during the summer months these pellets break down rapidly among moist ground

vegetation. The study suggested that the wood mouse was the preferred prey of the tawny owl, and the bank vole was the secondary prey species. Tawny owls also consume large amounts of earthworms which can represent the same weight as vertebrates in the fur pellet. They do not use the same station for producing pellets but are continually moving around their territories and searching for these pellets can be time-consuming (Southern & Lowe, 1982).

Other owl species which are predatory on small mammals include the little owl (*Athene noctua*) long-eared owl (*Asio otus*) and the short-eared owl (*Asio flammeus*). The little owl can pulverise vertebrate prey remains beyond recognition and tends to prefer invertebrate prey (Love, *pers comm.*). Love (2005) found that the long-eared owl selected heavily for shrew prey species (as does the short-eared owl) as it hunts in moorland.

3.3.3 Questionnaire Survey Results

3.3.3.1 *Advantages of owl pellet surveys*

Most respondents found this technique inexpensive and the species could be readily identified if good keys were used and some training given. It was considered less labour intensive than trapping. The collected pellets could be analysed at any time. Other respondents felt it was a non-invasive technique which could offer presence (but not absence) data. Another noted that this method was useful for recruiting volunteers as it could also attract bird watchers and others suggested that it was ideal for survey demonstrations. It was considered a good method for studying changes in barn owl diet over time and, therefore, had the potential to monitor population changes in small mammal prey. Several respondents felt that barn owls were capable of catching a large range of small mammals and the pellets could be regularly collected from roosts in reasonable numbers. One respondent noted it was a useful technique as owls can hunt in habitats which are difficult for humans to access.

3.3.3.2 *Disadvantages of owl pellet surveys*

Several respondents found it difficult to locate known owl roosts for the collection of pellets. Some felt they could not obtain large enough samples, especially in relation to known time periods. Some found it difficult to estimate the owl's foraging area and, therefore, the area from which the sample has arisen. Selective hunting by owls meant that small mammal population information, e.g. the proportion of total small mammal biomass could not be extrapolated from pellet analysis. Some respondents felt that expertise and additional equipment were required to accurately identify the small mammal remains (especially the teeth) in the pellets. One respondent noted that a skeleton can often be distributed over several pellets, and another felt the location of the prey species was accurate only to a few kilometres due to the range of the owl's pellet deposition. They also found that the date of small mammal presence could not be determined unless the date of pellet deposition was also known. One respondent pointed out that this method assumes that owls do not use random hunting techniques and there may be a bias towards nocturnal/crepuscular small mammals. Restricted access to pellets at some times of the year due to the barn owl breeding season was also suggested as a disadvantage. Some respondents felt that owl pellet surveys were useful for monitoring change in the barn owl diet but not necessarily small mammal population trends. It was also suggested by several respondents that the content of owl pellets is heavily biased towards field voles.

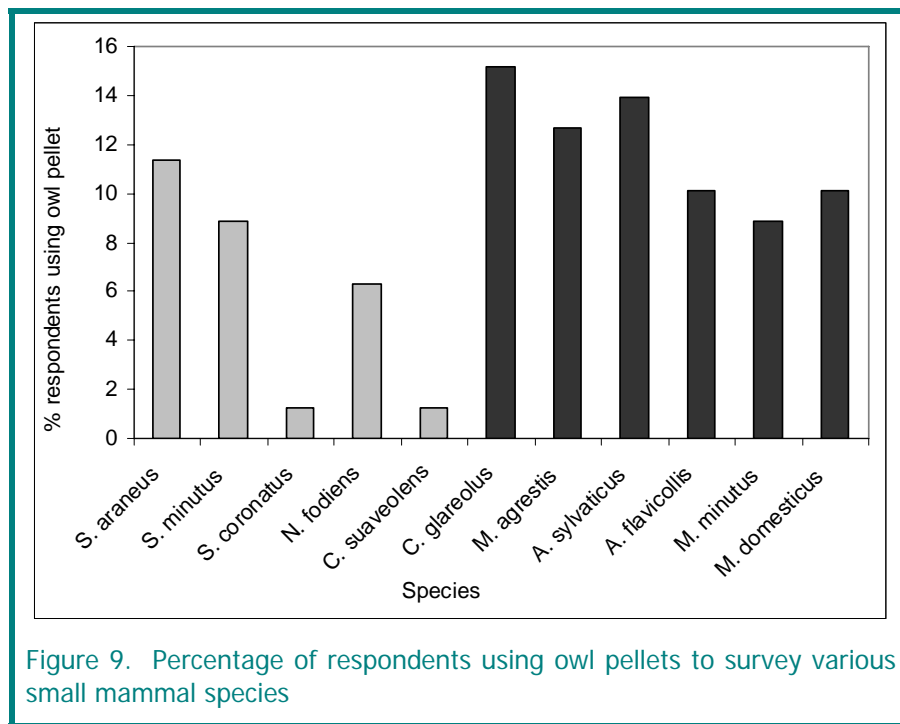

3.3.3.3 Volunteer Effort and Training

Most respondents considered that the training for owl pellet surveys should be a shorter period than live trapping ($1/2$ -1 day workshops). All respondents felt that when analysing owl pellets, it was essential to supply good identification keys and a trained leader initially.

3.3.3.4 Direct Costs

With owl pellet surveys, costs were considered low but considerable time was spent collecting and analysing samples. Access to good reference materials/keys, a microscope or magnifying glass and dissection kit were also considered essential. Travelling and postage costs were also noted.

3.3.3.5 Additional Comments

For this technique, feedback to volunteers was thought to be essential to ensure the continued support from pellet collectors. It was also considered important to maintain contact with other organisations, e.g. BTO and RSPB at a national level, and Wildlife Trusts at county level, when carrying out these surveys. It was suggested that this could be helpful in identifying suitable locations for pellet collection. Pellets should be labelled with collection date and location. The date of deposition and location of the owl pellets were also considered essential information.

3.4 Faecal tubes/bait tubes



The Mammal Society Water Shrew Survey (2004-2005) asked volunteers to choose survey sites in the summer (July-September) and the winter (December-April) to look for evidence of water shrews. Faecal tubes are an ideal method for surveying shrews as they are naturally inquisitive, readily investigating new objects (Churchfield *et al.*, 2000). The bait tube method involves placing lengths of baited tubes in bankside vegetation. Small mammals, including the water shrew, will enter the tubes to feed on the bait and linger long enough to defecate inside the tube. As water shrews are the only species which feed upon aquatic invertebrates, evidence of these prey items can be seen in the shrew scats and used to determine the presence of water shrews at a site.

The bait tubes are 20cm lengths of white plastic waste pipe with a 4cm diameter (30m can be obtained for ca. £15.99). Frozen blowfly pupae (casters) are recommended as bait as they readily attract shrews and can be easily distinguishable from scats. A nylon net baffle covers one end of the tube and is secured by a rubber band. This can be frequently bitten through by small mammals but this is unimportant because its only function is to contain the bait during transit and installation of the bait tubes. The bait tubes should be placed close to the water in aquatic habitats and amongst cover where possible. Thorough drying of the resulting scat samples enables them to be stored for an unlimited time before examination.

3.4.1 Advantages of faecal tubes/bait tubes

Bait tubes are a cheap and simple technique for detecting the presence of water shrews in a specified area and determining their habitat occurrence. There is less stress placed upon the shrews and other small mammals because they are not trapped by this device and can freely leave and enter and leave the tube at any time (Carter & Churchfield, 2005). The presence of common and pygmy shrews (*Sorex araneus* and *S. minutus*) can also be detected from scat measurements, the size of the invertebrate remains in the faeces, and the types of prey remains found. However, this requires a great deal of skill and is not generally recommended (Churchfield, 1984).

3.4.2 Disadvantages of faecal tube/bait tubes

Water shrews do not feed exclusively on aquatic invertebrates, feeding also on terrestrial invertebrates shared in common with *S. araneus* and *S. minutus*. (Churchfield *et al.*, 2000). The occurrence of water shrews at a site may be underestimated or give rise to ‘false negatives’, if the scats contain only terrestrial invertebrates and cannot be reliably distinguished from those of other shrews (particularly when fragmented) (Greenwood *et al.*, 2003). Conversely, if inexperienced volunteers are carrying out the scat analysis, ‘false positives’ could be recorded. The tubes can only be used reliably in habitats where water shrews have access to aquatic prey (Churchfield *et al.*, 2000). During **The Mammal Society Water Shrew Survey** some volunteers were concerned that the bait was being removed and no scats were deposited by the visiting animal. This may affect the motivation of volunteers who put much effort into surveying their sites with the expectation of a positive. However, this was not considered to have affected volunteer participation in The Mammal Society Survey (Carter & Churchfield, 2005).

The bait tube method is limited in terms of the information it can provide on population density. However, Churchfield *et al.* (2000) suggested that, if the home range and the daily movement patterns of the species are known, the tubes can be placed in sufficient numbers and intervals to increase the probability of capture.

3.4.3 Questionnaire Survey Results

3.4.3.1 *Advantages of bait tubes for water shrews*

Most respondents found that this method was low cost and non-invasive. Some noted that it was less time-consuming than live-trapping as the tubes could be left *in situ* without daily checks. Several respondents found the tubes were cheap to construct, light to carry in the field and simple to disperse and set up. In common with owl pellet analysis, there was no risk of death or stress to animals and minimal training was required to use this technique. Most respondents found that the tubes gave good small mammal presence data. The collected faeces could also be analysed at any time. One respondent noted that this method was more effective for water shrews than Longworth trapping.

3.4.3.2 *Disadvantages of bait tubes for water shrews*

One respondent found that the tubes were difficult to find on return to the survey site. Another thought that a large number of tubes are required to increase the probability of use by water shrews. Some respondents felt the tubes could be easily lost in heavy rain or the scats could be washed away when rivers spate. Others noted that this was only suitable for water shrews as the faeces from other small mammals was not so easy to identify. One respondent found that it was difficult to get a positive result and the water shrews could be defecating elsewhere. It was also noted that the scats will only confirm a positive, and cannot show a negative result. Another respondent found that the small mammal would bite through the muslin to get to the bait rather than go into the tube although this was not considered a significant problem. Two respondents felt that the analysis of scats (sent to experts for identification) was non-inclusive regarding volunteers.

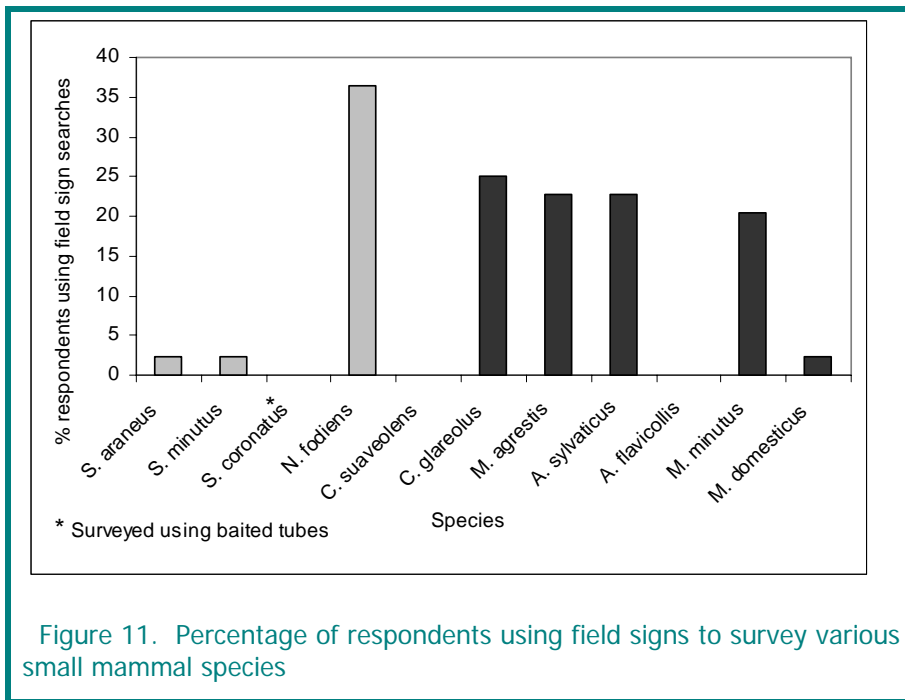

3.4.3.3 Volunteer Effort and Training

When surveying for water shrews using baited tubes, one respondent considered 1/2-1 day workshops were sufficient (not including scat analysis). Another felt that only guidance notes were necessary.

3.4.3.4 Direct Costs

For faecal tubes, costs included plastic tubing, muslin and a microscope (if analysing samples). The travel costs for this method were considered minimal as the survey site was only visited fortnightly.

3.4.3.5 Additional Comments

If the survey site was some distance away, instead of returning to inspect the tubes after two weeks, it was suggested that a local person could be asked to collect any scats and post them back to the field worker for analysis.

3.5 Hair tubes

3.5.1 Description of the Method

Hair tubes were developed by Suckling in 1977. The method detects the presence of species by attracting them to a baited tube which has double-sided adhesive tape attached to the interior. When the animal inspects the tube, it brushes against the interior and its hairs adhere to the tape (Suckling, 1978). Identification is made by viewing the sample hair under a light microscope, negative staining (Macdonald *et al.*, 1998) or by DNA analysis. Hair tubes are a measure of activity and are generally used to compile a species inventory or information on distribution (Barnett & Dutton, 1995).

Scotts & Craig (1988) modified the tubes by enlarging the diameter of the entrance and including a mesh chamber to prevent the bait being removed too quickly. Further modifications included moulding a dimple into the upper surface of each end of the tube. This created a constriction that the entering animal would have to squeeze under and appears to provide a better geometry for hair collection of smaller species (Sanecki & Green, 2005). More recently, a moulded plastic hair funnel, using purpose designed adhesive wafers, has been manufactured commercially (Lindenmayer *et al.*, 1999).

3.5.1.1 Cuticle scale patterns

The differences in the cuticle scale pattern and medulla type found in mammal hair can be used to distinguish species. Patterns in the shaft region of the hair can be used for identification by making a cast of the hair in nail varnish. A film of varnish is applied to a microscope slide and the hairs are laid on the film. Once hardened the hairs are peeled off, leaving behind a cast of the scale pattern. The medulla is located in the shield area of the hair and can be revealed when mounted in 70% ethanol (Twigg & Brown, 1975).

3.5.1.2 Cross-sectional patterns

Hairs can also be identified by their distinctive cross-section pattern but many hairs must be sectioned for final identification to be made. The hairs are embedded in wax or celloidin which is laborious. Hair sections that are sufficiently good for identification purposes can be made using a botanical sectioning technique with a strip of balsa wood which has hairs embedded on it in a film of celloidin (Twigg & Brown, 1975).

3.5.1.3 Negative staining

Species can be identified by the shape of the transverse section of the hair by using an ink solution. Hairs are placed on a slide together with a few drops of diluted ink and covered with a coverslip. The slide is then examined under a light microscope for the presence/absence of a concave section. A concave section is revealed as a groove in the transverse section and no groove will be shown in a convex section (Gurnell, Lurz & Pepper, 2001; Macdonald *et al.*, 1998). This method has been widely used for squirrels and, as shrews have defined cross sections in their hair, there may be the potential to use it for small mammals.

3.5.1.4 Hair measurement

A new method has been developed to distinguish between the 3 shrew species on mainland UK. Hair tubes were used in the first year of a study and the results were compared to live trapping used in the second year to estimate true abundance. Instead of using sticky tape inside the hair

tubes, strips of 'Faunagoo' glue (www.faunatech.com.au), which is an effective adhesive, even in wet conditions, were used. Three different sized tubes were bound together to enable selection between the shrew species. This was partially successful, with most of the hair in the smaller tubes being from pygmy shrews. Measurements were taken with the hairs remaining *in situ* on the sticky strip. The measurements were statistically repeatable and provided an 85% correct classification of the shrew species. The study suggested that there was potential to use similar measurements to distinguish between rodents. However, shrews have fairly clearly defined types of hair (i.e. guard hair, under hair etc) whereas rodents have more variation in hair type. There is also some uncertainty about the use of hair tubes as a survey method as the capture rate is not estimated and this will undoubtedly differ between sites and between seasons. It was also noted that measuring hairs can be time consuming and required some practice (Pocock & Jennings, in preparation).

3.5.1.5 DNA Library

The Joint Nature Conservation Committee (JNCC), the Environment and Heritage Service (EHS) and the Forensic Science Service (FSS) have produced a reference library of DNA information on 28 mammal species (Wetton *et al.*, 2002). The library includes the small mammal species discussed in this report. Once made accessible to the public, the library will offer a simple and quick method for identifying small mammal hairs collected from hair tubes. More importantly, it has the potential to involve large numbers of volunteers who do not necessarily have mammal identification experience but wish to follow through their tube surveys. However, the success of this method is dependent upon whether a cheap and automated DNA sequencing system can be developed (Battersby & Greenwood, 2004). The use of real-time PCR analysis could offer an efficient and cost-effective method to identify mammal hair.

3.5.1.6 Real-time PCR

Polymerase chain reaction (PCR) is a technique for amplifying DNA sequences *in vitro* by dividing the DNA into two strands and incubating it with primers and DNA polymerase (Wetton *et al.* 2002). With real-time PCR, species-specific fluorescent primers and probes are used to identify individual species from a hair sample, mixed or otherwise, unlike conventional PCR, where the analysis is carried out on each individual hair. The detection and identification are undertaken in one process which hastens identification, reduces sample handling and the risk of cross-contamination. Real-time PCR is easier and less time-consuming than conventional PCR which requires restriction enzyme analysis or DNA sequencing of the amplified product to determine species identity. Restriction analysis and DNA sequencing require relatively large quantities of a pure single band PCR product and can be very difficult to achieve from some DNA samples. There is less cost involved in real-time PCR (ca. 5-15 Euros/sample) and the success rate is much higher than conventional PCR. There has been a 100% success rate using real-time PCR for species identification of pine marten scats from fox scats (O'Reilly, *pers comm.*). However, there may be some doubt that DNA hair analysis is a suitably inclusive monitoring technique for volunteers.

Real-time PCR has not been used for small mammal species identification to date. However, The Waterford Institute of Technology (WIT) is currently working to develop hair capture tubes and real-time PCR tools for all small mammal species with samples being provided by The Mammal Society and The Wildwood Trust. Recent work at WIT has led to the development of very efficient hair tubes for collection of hair samples from pine marten. The methodology will be adapted to match smaller mammals and tested locally in Waterford and in Wildwoods Trust, Kent. As well as hair analysis, identifying small mammals from the DNA in faeces will also be investigated.

3.5.2 Advantages of hair tubes

Hair tubes are relatively non-invasive as there is no risk of trap deaths and less effect on the movement/spatial parameters of individuals through stress and temporary absence from home range/territory (Ansell, *pers comm.*). Equipment costs are minimal and the tubes are simple to construct from commercially available materials. The tubes can be set up and checked by volunteers and there is a potential for covering a larger area than using traps for the same field effort. They also have an advantage over trapping in that they can sample more than one species of small mammal and can be left in the field for some time without the need for daily monitoring (Mills *et al.*, 2002). Where other equipment is in limited supply, hair tubes can be useful to determine the most suitable places to position conventional traps. They are relatively inconspicuous in the field (Dickman, 1986) and are especially useful for arboreal and trap-shy species (Macdonald *et al.*, 1998). Hair tubes can be used in urban environments where a risk of vandalism or theft may prevent the use of more costly live traps (Dickman, 1986; Baker *et al.*, 2003). The results of a study of small mammal presence in an urban habitat by Dickman (1986) indicated that hair tubes were more effective than Longworth trapping although no assessment of population size or movement could be inferred. Other studies (e.g. Garson & Lurz, 1998) have shown a correlation between hair tube use and population estimates derived from CMR data. Until a suitable guide to identification or a reference collection is available, the technique could be used to undertake preliminary investigations over a large area and therefore identify areas that might be suitable for more intensive studies. Although shrews tend to leave few hairs on the adhesive tape, larger samples can be acquired by placing more tape around the open ends of the tube, increasing the likelihood of the animal brushing against the adhesive (Dickman, 1986).

Hair tubes are not a replacement for live trapping methods, particularly in detailed small-scale studies. However, the limitations of the hair tube technique are balanced by the potential for its application at landscape scales and its ability to return useful data for reasonable cost and effort (Sanecki & Green, 2005). Therefore, there may be potential for using this method to estimate population trends (Battersby & Greenwood, 2004).

3.5.3 Disadvantages of hair tubes

Current identification methods for hair analysis (i.e. conventional PCR) require time and expertise. The adhesion of the double-sided tape can be lost in wet weather and study results can often be inconclusive as new or unexpected species emerge (Dickman, 1986). Hair tubes cannot distinguish the number of individuals of the same species visiting a tube (Lindenmayer *et al.*, 1999). Mills *et al.* (2002) suggested that using hair tubes as a sole survey technique was not only ineffective but had the potential to produce misrepresentative data on population. It is difficult to distinguish between the hair of *Apodemus* spp. and *Sorex* spp. Existing data on the distribution and habitat of the species is required to validate results. The technique does not tell you anything about the animals that may be present but do not enter the tubes. Lindenmayer *et al.* (1999) found that hair tube size and configuration determined the types of animals that could be detected. The effectiveness of a hair tube is dependent on its ability to entice an animal to come into contact with the adhesive surface and leave a sample. Important design considerations include tube diameter, location of the adhesive and accessibility of the bait (Sanecki & Green, 2005).

3.5.4 Questionnaire Survey Results

3.5.4.1 Advantages of hair tubes

This method was little used by respondents and only two accounts were returned. They both found this method to be cheaper and less time consuming than live trapping. One pointed out

that this method could be suitable for use in areas prone to disturbance, theft or vandalism as the equipment was less costly to lose than Longworth traps. Hair tubes were considered useful for ascertaining species presence, especially those harder to live trap such as dormice or harvest mice.

3.5.4.2 Disadvantages of hair tubes

One respondent found that this technique was time-consuming post-survey when species were required to be identified from hair samples. Specialist skills and a good reference collection are needed for this. Without this expertise there may be potential for misidentification. It was also suggested that the tubes were light enough for squirrels and badgers to remove from a site. Both respondents felt that population enumeration techniques were likely to be less accurate than live trapping and hair tubes are unlikely to detect small scale changes in population size. They also found that the double-sided sticky tape inside the tube lost its adhesiveness in wet weather or in long, wet vegetation. The lack of a good hair identification reference for British species of small mammals was also mentioned.

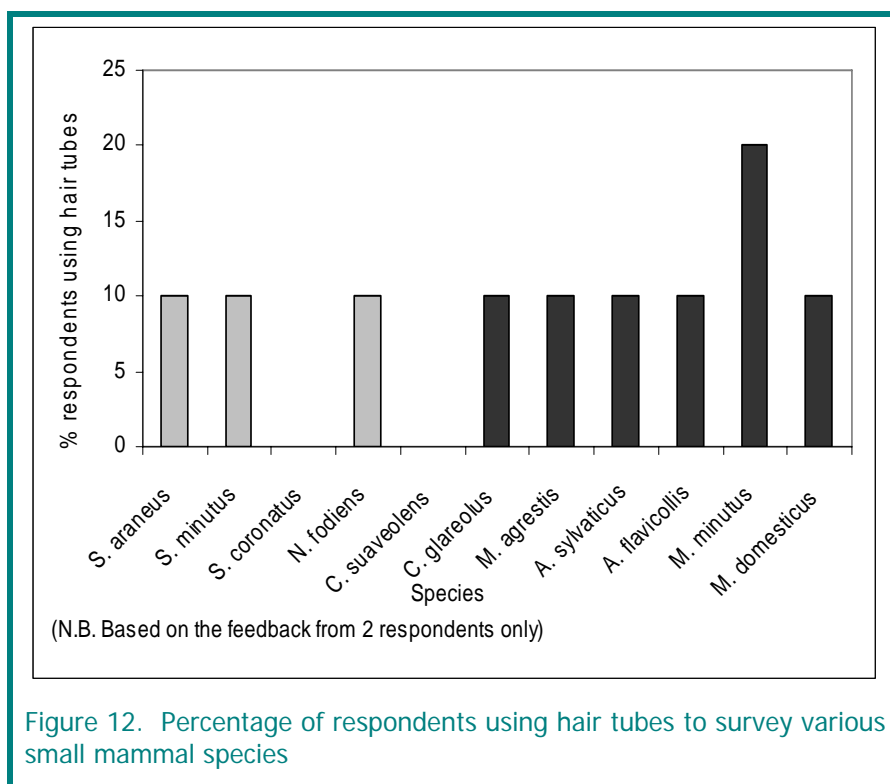

3.5.4.3 Volunteer Effort and Training

For hair tube surveys, it was suggested that minimal training was required for the construction, placing and collection of tubes but much more training and experience were needed for the analysis and identification of the samples.

3.5.4.4 Direct Costs

The material costs for hair tubes were similar to that of faecal tubes.

3.5.4.5 Additional Comments

Some respondents felt that hair tubes should be used following a live trapping study in similar habitat/time of year to calibrate results for population enumeration. The tubes were also easy to misplace in the field and required marking out. It was considered important to ensure that

enough hair tubes were distributed across a survey site to cover losses from squirrels, badgers and anything else with a taste for peanut butter. However, peanut butter was thought to be good bait in hair tubes as it does not readily fall out of the tubes when they are being placed. The best results were obtained from long-term studies concentrating on a particular area and it was recommended that surveys are kept small and focused allowing plenty of time to carry out all the procedures. Hair tubes were considered very useful for studies over a wide area using less skilled volunteers. It was felt that although less information was gathered, a larger area could be covered. Survey costs could then be focused on the analysis of the hair samples.

3.6 Field sign searches

3.6.1 Types of field sign

3.6.1.1 Nest counts for harvest mice

Counts of the number of breeding sites can be used to estimate population. The number of sites can be multiplied by the mean number of individuals per site (this data can be obtained using a direct technique) (Macdonald *et al.*, 1998). Harvest mice have distinctive nesting sites which are unlikely to be confused with other nests. Nest searches are an efficient way to estimate breeding sites for the harvest mouse. The searches require less effort than trapping and enable the coverage of a large number of sites (Sargent & Morris, 2003). They can also be carried out alongside other methods including hair tubes and live trapping.

However, using nest counts is not necessarily comparable between habitats where visibility differs and breeding nests may only be built in certain habitats. Spring and summer nests are often difficult to detect or they may be situated in sites with little access, i.e. hedgerows or cereal fields. Nests can be less visible in the summer as there is an abundance of vegetation and the nest colour will tend to change with the season. However, the supporting structures will keep some nests upright and therefore visible in the autumn and winter when other grasses give way (Harris, 1979). There is a risk that data on nest occupancy and individuals present may be misinterpreted because of the use of several nests by one individual (Trout, 1978). Searching for nest sites may also disturb the animals present (Macdonald *et al.*, 1998). The nest structure breaks down quickly after abandonment and not many of the nests are constructed above ground level after September (Warner & Batt, 1976). Often hedge-cutting will coincide with the peak breeding season of the harvest mouse and destroy nest evidence (Bence *et al.*, 2003).

3.6.1.2 Feeding signs

Some species leave distinctive feeding signs (e.g. field vole) and this method can provide presence/absence data in distribution studies. Approximate numbers can be determined by estimating the food resources and dividing by the daily dry weight consumption (Macdonald *et al.*, 1998). In lowland habitats Wilkinson *et al.* (2004) found that runways were the best sign index for field voles while Wheeler (2002) found that fresh grass clippings produced the best sign index for field voles in upland areas. However, Village & Myhill (1990) found that seasonal variation affected food availability and therefore the presence of feeding signs. It can also be problematic distinguishing between the signs of different vole species

3.6.1.3 Tracks

Track counts can offer an effective method for estimating abundance where species prove elusive. Mammal presence can be detected from tracking tunnels or track-plates (Carey, Biswell & Witt, 1991). The tracking tunnels are baited octagonal polyethylene tubes which allow the target animal to walk through onto a piece of absorbent tracking cardboard with a sealed ink coating. The footprints left can later be verified from field guides (Hasler *et al.*, 2004).

In a North American study, Carey *et al.* (1991) recommended that track-plates are dusted with silicone or talcum powder and are either placed singularly or within box-tunnels. This method was found useful for recording patterns of abundance for arboreal species and was found to contrast favourably with abundance results obtained from point counts and live trapping. Lord *et al.* (1970) used plastic floor tiles with one side blacked with printer ink. These were laid out in a grid to record small mammal tracks as a frequency index.

Footprint tracking is commonly used to provide relative indices of rodent density in New Zealand. Brown *et al.* (1996) used snap traps and tracking tunnels to estimate the density and habitat use of the ship rat (*Rattus rattus*) and house mouse. The study suggested that there is a linear relationship between the ship rat absolute density and tracking rates. The relative index based on tunnel tracking rates was considered a cheap and reliable method to monitor rat abundance in the same place.

Monitoring using tracking techniques involves little cost and is relatively simple to carry out. However, it is often difficult to distinguish between mice and vole prints (Macdonald *et al.*, 1998). Footprints can also get overlaid, making it difficult to see them clearly for identification. Brown *et al.* (1996) suggested that scent marking by other mammals may cause the target species to avoid the tunnels.

3.6.1.4 Dropping boards

Weatherproof plywood or plastic tiles can be positioned on a grid and faeces deposited on these boards is counted periodically to give a basic abundance index (Macdonald *et al.*, 1998). However, small mammal droppings are often difficult to identify to species with the exception of water shrews and field voles (Sargent & Morris, 2003). The boards need to be checked regularly and brushed clean after each count.

3.6.1.5 Runs/track ways

See field vole section

3.6.2 Advantages of field sign searches

Trapping often exhibits biases according to the traps and baits used (O'Farrell *et al.*, 1994; Torre *et al.*, 2004) and is also sensitive to sampling effort (Torre *et al.*, 2004). Some mammal species are difficult to census because they are highly secretive and/or occur at low densities. In such cases, field sign searches can be employed. Small mammals tend to leave some record of their presence in an environment (e.g. faecal pellets, tracks, burrows or feeding signs). Learning how to identify and interpret evidence left by mammals can offer information about their habits that cannot be acquired by other means (Wemmer *et al.*, 1996). Jaksic *et al.* (1999) suggested that for survey accuracy, live trapping should be used in conjunction with a range of indirect techniques to assess mammal diversity in little known sites. The degree of disturbance to the study population is greatly reduced, equipment costs are minimal and field sign searches have the advantage of a single site visit (Wilkinson *et al.*, 2004). Simple walking and searching techniques are more likely to attract volunteers, especially if they are given the opportunity to develop field skills in species identification. Conversely, they may become less motivated if signs are not found or species not seen.

For some species (e.g. field vole) in certain habitats, sign indices may also provide information on changes in abundance. However, in contrast to live trapping, relatively few field sign methods provide information of sufficient detail. The precision of indirect methods in quantifying population change is uncertain and not well-documented. However, using field signs for small mammal monitoring is relatively inexpensive and encourages volunteer involvement. They are less time consuming and less labour intensive and consequently can be used to cover large areas. Unlike trapping, the animals are less likely to be disturbed (Macdonald *et al.*, 1998).

3.6.3 Disadvantages of field sign searches

The chance of finding signs varies between habitats and species and is also reliant on observer effort. Field sign techniques require accurate calibration to determine a population index before

study results are deemed reliable. Validation experiments stratified for habitat may need to be carried out beforehand (Macdonald *et al.*, 1998). If using small mammal paths it is worth noting that they can remain hidden in areas where the animals have restricted their activities to ditches, hedgerows and other linear habitats (Twigg & Brown, 1975). Redpath *et al.* (1995) found that field signs that are not fresh may also be indicative of past rather than current abundance.

3.6.4 Questionnaire Survey Results

3.6.4.1 *Advantages of field sign searches*

One respondent thought that field sign searches were useful for providing additional information when used in conjunction with standard survey techniques. Another felt that this method was effective for establishing the presence of species, especially when using feeding signs. Two respondents considered that this method presented no risk to the animal and could effectively identify certain species depending on the habitat. The majority of respondents considered this technique cost-effective as little or no equipment was required. Some thought they could be useful for encouraging volunteers, especially younger people. It was also suggested that volunteers may be able to carry out these surveys at various times of the year and/or when they are out for recreational walks. Several respondents found that it was possible to take part in field sign surveys without great expertise and it provided a good opportunity for volunteers to broaden their field knowledge. It was noted that this method could be easily repeated at the same site over a long time period. Two respondents pointed out that by using this method, several species could be surveyed simultaneously, therefore, making the scheme more interesting to participating volunteers. Other respondents suggested that nest searches were an effective method for detecting the presence of harvest mice at a site and annual nest counts for this species at a single site could provide an indication of abundance and trends in their populations over time. Nest searches were considered to be relatively non-invasive as long as they were carried out after the end of the harvest mouse breeding season (i.e. October). One respondent felt that field signs were an effective method for detecting the presence of field voles.

3.6.4.2 *Disadvantages of field sign searches*

The majority of respondents found field sign searches were time-consuming and labour intensive. It was felt that time restrictions could limit the thoroughness of the searches. One respondent found it difficult to age field signs and, therefore, to estimate the small mammal presence accurately. Several respondents felt that some expertise was required to detect signs and a lot of experience needed to cover a range of species with any accuracy. Two respondents felt that most small mammal species do not leave obvious field signs. They noted that harvest mouse nests can be well hidden in vegetation and can consequently be missed. They also discovered that bad weather during this time of year could degrade or destroy existing nests. Respondents suggested that, because the animals are not seen or handled, this method may not encourage volunteer participation. One respondent commented that field signs searches could give presence/absence data but no detail on populations (with the exception of harvest mice). Seeking landowner permission to carry out field sign searches was also considered time-consuming.

3.6.4.3 *Volunteer Effort and Training*

When looking at field signs, one respondent felt that a full day training course was necessary to enable them to identify the signs from different species. Another pointed out that this method required an all-round knowledge and it may be easier to train an individual to survey a single species at one time.

The amount of training to find field signs differs for each species, e.g. field vole surveys require minimal training whereas harvest mice nest counts require a consistent and detailed approach. Some respondents suggested that when using quadrat methods for field signs, training should include how to age droppings/clippings and calculate populations. It was generally considered that field sign training should incorporate actual field experience.

3.6.4.4 Direct Costs

No particular equipment was required for field sign surveys and the main cost mentioned for this method was time and labour.

3.6.4.5 Additional Comments

It was suggested that burrow signs should be associated with feeding signs. When nest searching for harvest mice one respondent recommended looking among the most impenetrable areas of vegetation as this is where they will often nest.

3.7 Other survey methods

3.7.1 Cat predation

In **The Mammal Society Cat Predation Survey** (Woods, McDonald & Harris, 2003) a questionnaire was used to survey householders regarding the numbers of animals brought home by domestic cats, *Felis catus*. The study was conducted between 1st April and 31st August 1997 and a total of 14,370 prey items were recorded as prey of 986 cats living in 618 households. The wood mouse was the most frequently recorded small mammal (1617), followed by the field vole (853), common shrew (807), house mouse (622), bank vole (544), pygmy shrew (320), harvest mouse (177), water shrew (27) and yellow-necked mouse (17).

A cat predation survey was also carried out over 2 years as part of small mammal study in Jersey (Magris & Gurnell, 2000). A questionnaire survey was circulated to householders through the local press, veterinary surgeries and catteries. The hunting activities of 26 cats were recorded during 1999. The proportions of prey items were scaled up to give an estimated annual catch island wide. For an island cat population of 25,500 domestic and 200 feral, a total of 289,882 prey items were estimated. The wood mouse was the most frequently caught small mammal (122,549), followed by bank vole (46,296), French shrew (30,259), lesser white-toothed shrew (13,919), brown rat (4841) and house mouse (2421). In a recent survey of cat predation in Bristol, Baker, Bentley, Ansell & Harris (2005) also found that the wood mouse was the most commonly recorded prey species.

The Jersey study demonstrated the difficulties of obtaining large enough samples for analysis as many cat owners were not keen to record the hunting habits of their cats over a long period. The survey was dependent on the good management and identification skills of willing cat owners. Cat predation surveys are considered a crude approach providing presence (not absence) data on small mammal populations. These surveys often reveal more about cat behaviour than about prey species (Magris, *pers comm.*). In a study of small mammal species in urban habitats, Baker *et al.* (2003) demonstrated a negative correlation between numbers of wood mice and the numbers of cats visiting suburban gardens. The study suggested that high levels of cat activity will significantly impact the numbers of wood mice in local areas.

3.7.2 Scentinel bait station

The 'Scentinel Mk 4' is an automated bait station for monitoring small mammals between 40g and 2kg. It is equipped with a weighbridge, bait canisters and an infrared camera. The trap can be programmed to respond to specified weight classes and the size of the tunnel entrance can be altered to exclude larger mammals. Inside the station, dispensers can be programmed to deliver measured amounts of bait and/or lure and these substances are kept fresh in sterile cans. The camera is triggered by animals of a specified weight stepping on to the weighbridge. The time and date of each visit and the weight of the animal is also recorded. 212 images can be digitally stored and photograph identification is checked against mammal footprints left on tracking papers placed in the station. The footprint papers were used in the trials for this device in case of camera and/or weighbridge failures. Ultimately, the 'Scentinel Mk 4' has been designed to be left on a site for months to collect data without being attended by a surveyor. This will potentially eliminate the labour costs that other trapping devices incur (King, Martin, McDonald, Tempero, Dekrout, Holmes & Stirnemann, 2005). The trap is in the pre-commercial stage and further information can be obtained by contacting Dr Carolyn King at c.king@waikato.ac.nz.

3.7.3 Dormouse nest box records

The National Dormouse Monitoring Programme (1991-present) covers some 243 sites across the UK. Volunteers are asked to check a minimum of 50 nest boxes per site over a 10 day period every month from May to October. The presence of other small mammals, including yellow-necked and wood mice, has been recorded. Marsh (1999) found yellow-necked mice were the most frequent visitors to dormouse nest boxes, more so than any other small mammal except dormice. It was suggested they made most use of the boxes in the autumn, possibly due to shortages of natural nest sites.

During 2004, **The National Dormouse Monitoring Programme** found that, of the 167 sites monitored, 97 sites returned records of other small mammals encountered while examining the nest boxes. The wood mouse was most frequently encountered. Other species included yellow-necked mice, shrews and bank voles (Sharafi, 2005). Whilst this method is considered unreliable as a means of sampling yellow-necked mouse populations, nest box records may still be a useful indicator of crude inter- and intra- population trends (Marsh, 1999).

3.7.4 Questionnaire Survey Results

3.7.4.1 *Cat predation surveys*

One respondent felt that cat predation surveys were more useful for detecting house mice than other standard techniques but could potentially be used for monitoring a range of other species if the scheme involved enough cat owners. Another respondent noted that this technique did not require much labour. It was also felt that cat predation surveys have the advantage that those with no survey or identification skills can still get involved. If the cat owner is uncertain of the species the animals can be sent to experts (providing the specimen is fresh enough for identification).

One respondent found this technique was too dependent on external sources (i.e. cats and people) to provide a significant volume of data. The method tended to reflect observer bias rather than provide objective small mammal data. Identification of the specimen was inconclusive unless the corpse was frozen and verified by an expert. Another respondent noted that much of the small mammal prey was totally consumed by the cat which leaves little evidence for identification. Also, many of the prey species were eaten or discarded away from the home. This made it difficult to assess a cat's hunting range and, therefore, the area from which the sample was caught.

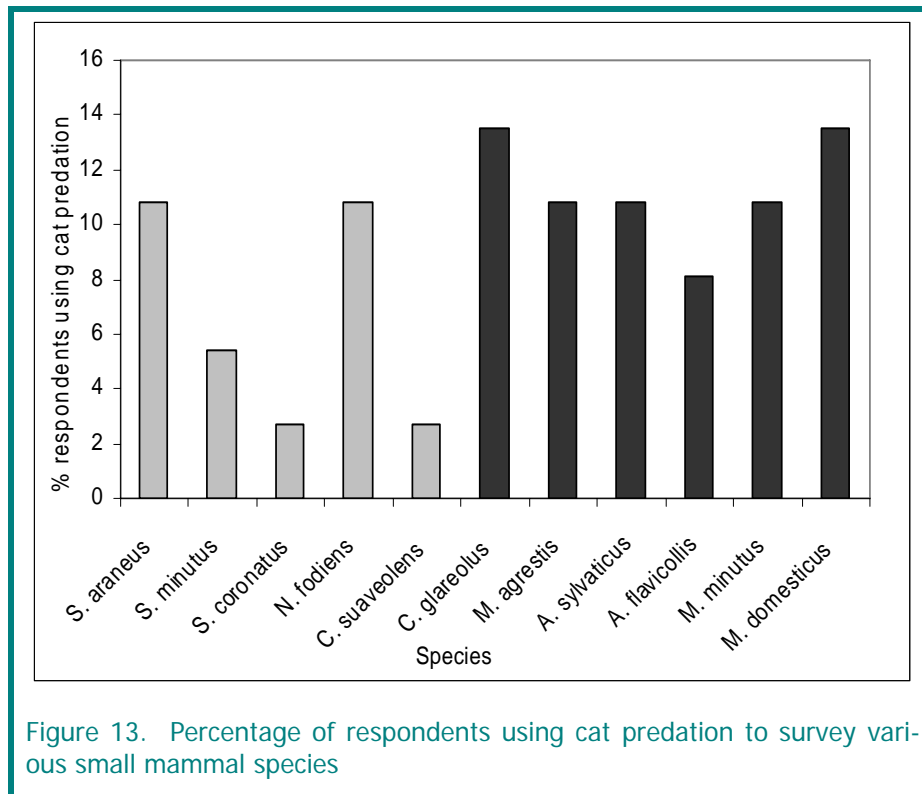

3.7.4.1.1 Direct Costs

Cat predation surveys were found to involve little cost other than publicity material and support time. One respondent pointed out the cost of travelling when collecting cat catches and also postage costs when specimens are submitted for verification.

3.7.4.1.2 Additional Comments

One recommendation was to ask farmers, especially in the more outlying areas, to keep any catches made by their farm cats. These catches were kept and later identified by a visiting expert. It was suggested that a large network of farm contacts could be formed by giving talks and demonstrations in these rural areas.

3.7.4.2 Dormouse nest boxes for other species

Two respondents found that nest boxes were often occupied by species other than dormice and that nest box checking required minimal effort over a long period of time. Both respondents found this method variable and limited to nest box sites. With little detail on the small mammal populations, it was difficult to judge change over time. It was also noted that a licence is required to check dormouse nest boxes.

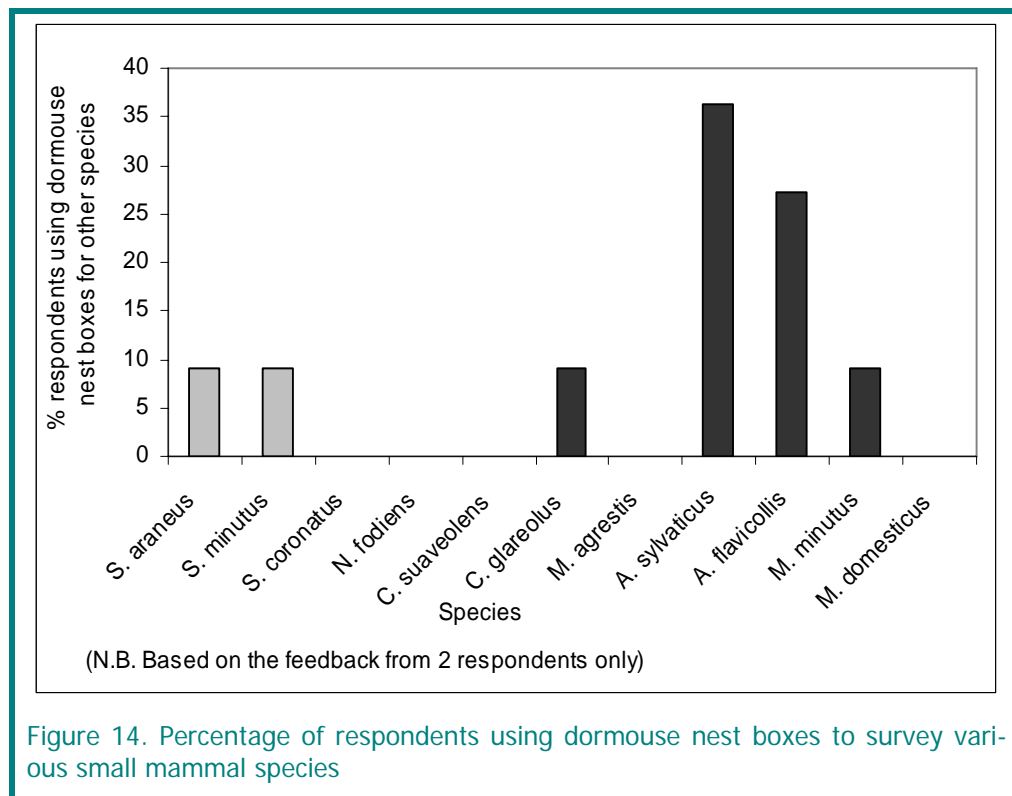

3.7.4.2.1 Volunteer Effort

It was noted that recording other small mammal species in dormouse boxes could be easily incorporated into general dormouse survey training.

3.7.4.3 Refugia

One respondent used this method while surveying for reptiles. They found that the refugia materials were cheap and expendable and, therefore, theft was less of an issue. It was also considered useful to survey for two different species simultaneously and the effort involved was minimal. It was felt that limited data were collected using refugia. There was little scope for volunteer involvement as there was no opportunity to handle the animal. This method was also found to be biased towards field voles.

3.8 Summary

See Table 2.

Table 2. Summary of suitability of trapping methods for each species

	<i>Live trapping</i>	<i>Owl pellet analysis</i>	<i>Field sign searches</i>	<i>Hair tubes</i>	<i>Baited tubes</i>	<i>Cat predation</i>	<i>Found in dormouse nest boxes</i>	<i>Refugia</i>
Common shrew	****	***		**		*		
French shrew	****	***		**		*		
Pygmy shrew	****	***		**	**** 1	*		
Water shrew	***	***		**	****	*		*
Lesser white-toothed shrew	****	***		**	**** 2	*		
Greater white-toothed shrew	****	***		**	****	*		
Bank vole	****	***		**		*		
Field vole	***	***	****	**		*		*
Orkney/Guernsey vole	***	***	****	**		*		
Wood mouse	****	***		**		*	*	
Yellow-necked mouse	****	***		**		*	*	
Harvest mouse	***	***	****	**		*		
House mouse	****	***		**		*		

**** Recommended techniques

*** Ancillary techniques

** Potential techniques (requires further development)

* Less useful technique

1 Pygmy shrew in the Isle of Man and Ireland

2 Lesser white-toothed shrew in the Isles of Scilly

4 Survey Design

4.1 Introduction

The design of multi-species surveys is always more complex than for single-species surveys. This is primarily because species occur at different intrinsic abundances and have different geographical distributions. When recording data on only a single species it is possible to tailor the sample size and sampling strategy to the population parameters for the species. But, in multi-species surveys these parameters are often quite different between species. Consequently, rare species may require a very large sample or large sampling units to obtain sufficient data to give power to detect change. Conversely, a common species might only need a small sample, to detect a given degree of change. If two such species are included in a single monitoring programme, using a single sampling strategy, this could have one of three outcomes:

- If a small sample size is chosen, which is adequate for the common species, then the rare species will be under-sampled. This may preclude any possibility of detecting change in the rare species.
- If a large enough sample size is chosen to detect change in the rare species, the common species will be over-sampled, so that unnecessary effort will be expended in detecting the required level of change.
- The sample size could fall between these two options, so that it is too small to detect a change in the rare species and unnecessarily large to detect the required change in the common species.

Similarly, ubiquitous and evenly distributed species may only require a simple sampling strategy. However, a species which has a limited geographical distribution, or is a habitat specialist, may require a stratified sampling strategy to optimise sampling effort. These various requirements are often difficult to reconcile and it is important to recognise that multi-species survey designs will always be a compromise.

Furthermore, Chapter 3 has shown that a number of different field methods are applicable to small mammal monitoring. Some, such as live-trapping, may be suitable for most species, while others are species-specific. This adds a further complication to the design of a generic survey method.

Finally, a nationwide survey such as the one proposed in this report will have to make use of volunteers. This will have three main consequences on the survey design:

- Firstly, volunteers are not usually prepared to travel long distances to their sites. This means that site selection and allocation can be difficult. Also, volunteers may reject sites for various reasons. Sites which appear to yield little information, or are in undesirable locations, may not be acceptable. These factors may introduce a non-random element to the sampling strategy, resulting in a biased sample.
- Volunteer turnover tends to be quite high (Noble *et al.*, 2005). This can either mean that sites are lost (and gained) during the monitoring programme, or that the volunteer covering a site may change over time. Both of these factors can influence the analysis of long-term monitoring data.
- Volunteer expertise is highly variable. This may range from a very high degree of small mammal expertise contributed by a full-time academic or researcher, to very low expertise, but high enthusiasm, from school groups or individuals who have been attracted by The Mammal Society literature and publicity. This may have the consequence of precluding some volunteers from using the more sophisticated field methods.

4.2 Sampling Strategy

The factors outlined in the previous section require a somewhat complex but versatile survey design. To this end, we are proposing a two-stage sampling strategy, utilising Ordnance Survey tetrads (grid squares of sides 2km) as the primary Sampling Units (**PSU**). Within each PSU, varying numbers of Secondary Sampling Units (**SSU**) can be located depending on the habitats available. Finally, within each SSU a fixed number of Field Method Units (**FMU**) are placed, which yield the raw data for monitoring. Each of these stages is explained in detail in the following sub-sections.

4.2.1 Sampling and Stratification

The monitoring programme is designed to cover the whole of the British Isles. There are approximately 64,000 tetrads in Great Britain and Northern Ireland, plus a further 16,000 in the Republic of Eire. We propose to draw a 4% random sample of tetrads (without replacement) from this sampling frame, giving a sample size of approximately 3,200 PSUs. This sampling fraction results in a mean straight-line distance to nearest PSU of 4.99km. Indeed, from 10,000 simulations, 96.5% of homes will be within 10km of a PSU and only 0.02% of homes will have the nearest PSU further than 16km. (Figure 15).

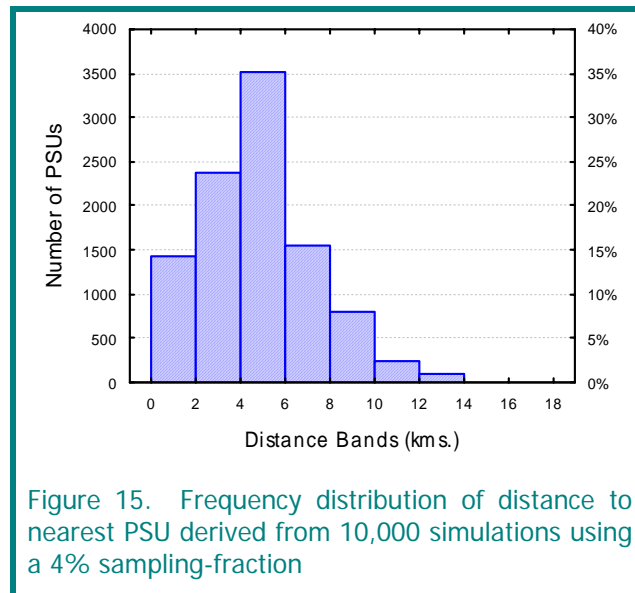

Volunteers will be assigned the nearest PSU to their home, although the rule will not be rigid. There may be reasons why a particular tetrad is unsuitable, in which case the next nearest will be assigned. Reasons might be the presence of a large river, resulting in a longer journey to cross it, or extremely difficult terrain. However, the use of two-stage sampling means that most PSUs should yield adequate opportunities for some SSUs. Volunteers may be assigned more than one PSU if they have the time to cover them and if their first PSU proves to harbour few suitable habitats (see section 4.2.3 below).

Stratification provides three main advantages to a sampling strategy:

- Firstly, it can be used to ensure an adequate coverage of the population, especially if the sample is small. This could be based purely on geographical factors, to ensure that all parts of the country are covered, or on other factors such as habitat. Proportionate or optimal sampling can be used in these circumstances (see e.g. Krebs, 1989).
- Secondly, it may be necessary to obtain separate estimates for geographical or administrative areas. This is related to the previous advantage, as stratification can ensure that each area has an adequate sample to provide the statistics of interest.

- Finally, the variate of interest may have greatly different values in different sub-populations. By stratifying on these sub-populations, it may be possible to reduce the errors (confidence intervals) in estimates of the population mean. For example, the distribution of yellow-necked mice is extremely patchy in England and Wales (Marsh *et al.*, 2001). Using a stratification based on their core and peripheral zones, it would be possible to reduce the overall error in population estimates, and probably reduce unnecessary effort in the peripheral zone.

Despite the advantages described above, it will be very difficult to apply any sort of stratification to the sampling strategy for this monitoring programme. Firstly, large-scale geographical stratification is rendered pointless by the fact that the general location of PSUs is determined by the location of volunteers. We may well use stratified sampling to ensure a minimum number of tetrads in Ulster, for example, but the number of those which are assigned as PSUs will be determined by the number (and enthusiasm) of volunteers in the province. Furthermore, with a relatively large sample size, simple random sampling will ensure adequate coverage of tetrads through GB and Eire.

Secondly, stratification based on habitat will not be practical as tetrads are likely to cover a number of different habitats. It could be argued that large-scale habitat, as represented by the environmental zones of the UK (Haines-Young *et al.*, 2000), could be used. However, this is largely a geographical zonation and will be subject to the same problems of volunteer location. Similarly, with stratification based on administrative areas, other solutions will be required to estimate statistics for these units.

Finally, stratification based on differing biological population parameters will be difficult to accommodate in a multi-species monitoring programme. Stratifying to optimise sampling for one species may have a detrimental effect on the sampling of others.

These factors, such as geographic, administrative and environmental zones, which stratification could have accounted for, can be analysed using *post hoc* classification of PSUs. Similarly, habitat characteristics will be used to determine location of SSUs, so habitat becomes a property of the second level of sampling.

However, there are two sampling issues which need to be addressed. Firstly, a simple random sample is likely to miss many of the smaller islands which constitute the British Isles. Specifically, there are three species of shrew confined to the Channel Isles and the Isles of Scilly and one species of rodent confined to the Channel Isles and Orkney (see Chapter 2) which would almost certainly be under-sampled, or even missed entirely, using the simple random sampling proposed. Sampling for these species should be carried out independently of the main sampling regime.

Secondly, many areas comprising small islands, such as the Orkneys, Shetlands, Hebrides and Scillies, may not be suitable for subdivision into tetrads, or the tetrads may span several small islets. It might prove a better strategy to use small islands (say less than 5km² in area) as PSUs in these circumstances. Much will depend on the ease of access to these locations and enthusiasm of volunteers. Within the PSUs, the procedures for using SSUs and the field methods would be exactly the same.

4.2.2 Primary Sampling Units

The Primary Sampling Unit (PSU) is 4km² in area and, in most cases, will contain a range of habitats. The first task for the volunteer will be to identify the broad habitat types which are present in the PSU. We have proposed seven broad categories (Table 3) subdivided into 23 specific

habitats. More importantly, the different microhabitats present in these habitats will determine which species are likely to be found and so the type of SSUs that can be set.

Table 3. Proposed general habitat categories, specific habitat belonging to each and examples of microhabitats which may be found in some or all of the specific habitats.

General Category	Specific Habitats	Examples of Microhabitats
Woodland	Deciduous Mixed Coniferous	Sparse ground cover within dense woodland Bramble / shrub patches Dense grassy clearings / rides Woodland edges
Open Farmland	Permanent grassland Grass Leys Arable Orchards	Sparse ground cover in leys or arable No ground cover in ploughed fields Dense cover in Set-aside fields Sparse ground cover
Field Boundaries	Hedgerows Fence lines Walls Ditches	Sparse ground cover within mature hedgerows Rank grassland alongside Reed / rush beds Inundated ground
Riparian	Rivers Streams Standing water Canals	Inundated ground Bramble / shrub patches Reed / rush beds Rank grassland
Moorland & lowland heath	Heather moorland Acid grassland Lowland Heath	Dense <i>Calluna</i> and ericaceous dwarf shrubs <i>Nardus</i> / <i>Molinia</i> grassland Pteridium stands Semi-improved grassland
Coastal	Saltmarsh Sand dunes Cliffs / downs	Dense ground cover (Purslane / aster / sea lavender stands) Dense ground cover (Dune slacks and marram grass stands) Short turf (<i>Araneria</i> grassland)
Urban	Road verges Parks & gardens	Dense rank grassland Dense cover in horticulture / flower beds

4.2.3 Secondary Sampling Units

Chapter 3 described in detail seven field methods which can be used to obtain data on the distribution and abundance of small mammals. Four of these have been recommended for use in this survey and in addition, an ancillary technique has also been recommended. As different methods can be used in different habitats and for a range of species, the Secondary Sampling Units have been designed to standardise these methods.

An SSU utilises only one method and has a fixed size. All SSUs are transects, nominally 100m in length, with ten points on each transect. Five different types of SSU have been defined (Figure 16):

- Harvest mouse nest transects
- Field vole sign transects
- Bait tube transects
- Extensive live-trapping transects
- Intensive live-trapping transects
- Owl pellet analysis – ancillary technique

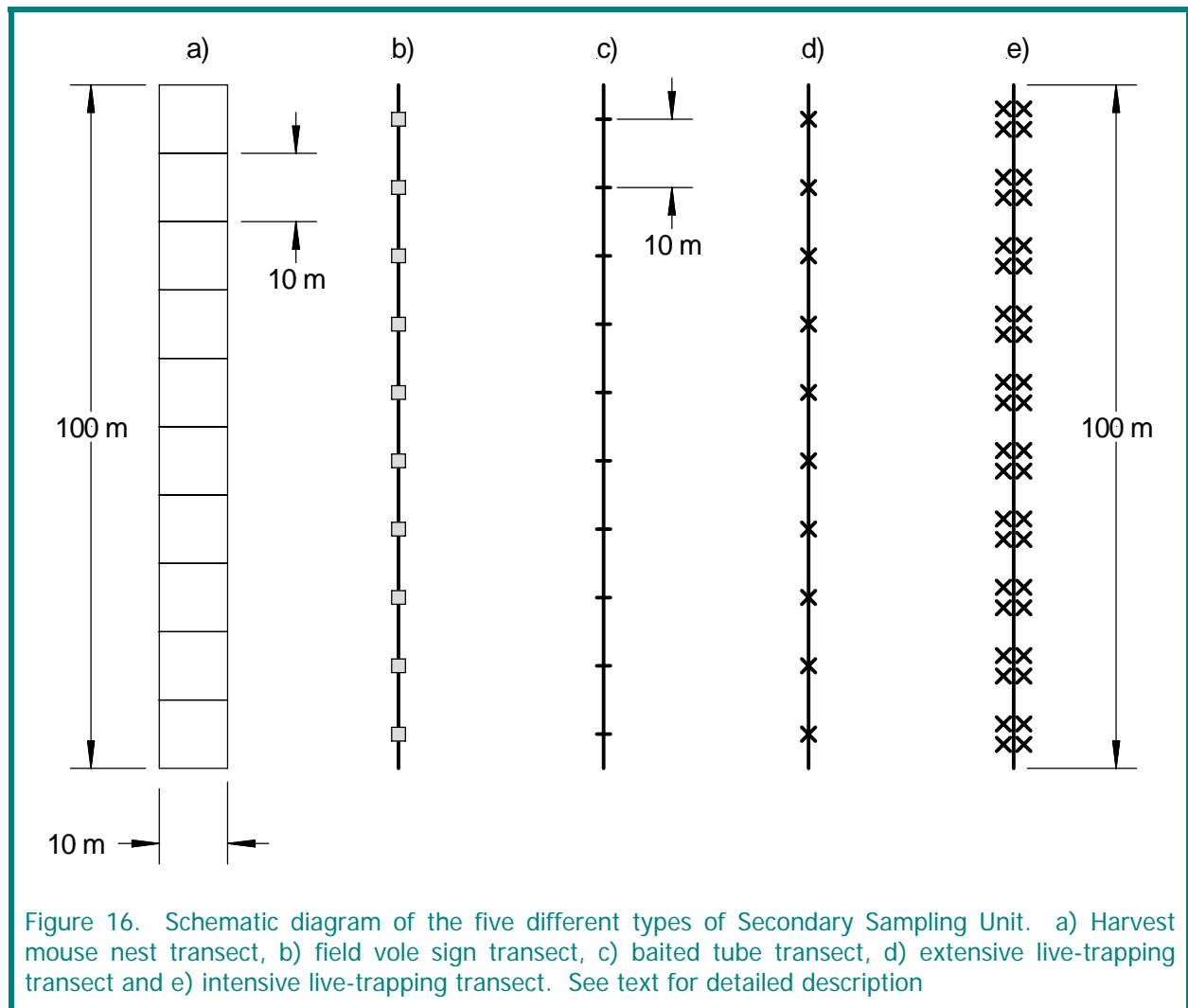

4.2.3.1 Harvest mouse nest transects

These transects comprise ten, contiguous, 10m x 10m squares covering a total area of approximately 1,000 m². Nests are counted in each square, providing ten integer counts from zero to n . However, if time is short it may be acceptable simply to record the presence of nests in each square.

This method requires only a single visit, with on-site time probably in the range of 1 – 2 hours. Consequently, several of these SSUs could be carried out in a single day.

4.2.3.2 Field vole sign transects

Field vole sign transects may be overlaid on harvest mouse nest transects, if the habitat is appropriate, or separately. They are a minor adaptation of the method of Wilkinson *et al.* (2004) and comprise ten 1m x 1m quadrats at 10m intervals along a 100m transect (leaving 5m at either end). Within each quadrat the presence of **runways** (worn paths weaving through the grass stems with evidence of chewed-off grass stems), **latrines** (collections of green/dark green faeces) and **feeding signs** (clippings of bitten-off grass stems and leaves often left in a criss-cross pattern) are recorded separately. In upland grassland, Wheeler (2002) recommended that the number of quadrats with clippings be used as the main statistic. This method also only requires a

single visit, probably taking slightly longer than harvest mouse nest transects. It is estimated that on-site time would be 2 – 3 hours, suggesting that two SSUs should be possible in a single day.

4.2.3.3 Bait tube transects

These transects are essentially the same layout as for field vole signs, with ten points at 10m intervals along a 100m transect. At each point a single bait-tube (as described in section 3.3.3) is laid for seven days. At the end of this period, the tubes are collected and the faeces present in each tube identified. The identification of water shrew scats requires experience and to avoid generating “false positive” records this should be undertaken by experts. It is not possible to distinguish between the scats of wood mice and yellow-necked mice and the identification of vole species from scats is not a definitive method, particularly if the scats have dried. It is also not easy to differentiate between the scats of common and pygmy shrews. This method is, therefore, principally useful for detecting the presence of water shrews. The presence of faeces from each species is recorded in each tube, giving a count out of ten.

This method requires two visits, so will be relatively more time consuming for PSUs which are a greater distance from the volunteer’s home. On-site time, however, will probably be around one hour per visit, although faeces collection and identification could add several hours to this.

4.2.3.4 Extensive live-trapping transects

These transects have the same layout as the bait-tube transects with ten points at 10m intervals along a 100m transect. At each point, a single Longworth trap is placed, requiring ten traps per SSU. Animals captured are identified to species and released without marking. The numbers of traps holding each species is recorded. This allows the “Presence-Absence Ratio (PA-ratio)” to be calculated for each species in each SSU (see below).

The traps are placed in the evening, prebaited with the doors locked open. They are revisited 24 hours later and the doors set to trap. Finally, the following morning the traps are checked, animals identified and released and the traps collected. This type of SSU, therefore, has three visits, although each is unlikely to take more than about one hour on-site. The process is designed to be carried out over a weekend, with traps laid on Friday evening, set to trap on Saturday evening, and the animals released on Sunday morning. Consequently, it may be possible to run two or three SSUs simultaneously over a weekend if the volunteer has enough traps.

4.2.3.5 Intensive live-trapping transects

Intensive live-trapping transects are similar in layout to the extensive transects, except that they have four Longworth traps per point, requiring 40 traps per SSU. Furthermore, captured animals are marked with a single fur-clip before release (except on the last trapping session) with no attempt to mark animals uniquely.

The extensive transects are also laid for longer. The traps are set during the first evening, baited and locked open. The next morning the traps are unlocked and in the evening the first “capture” visit is made to mark and release the captured animals. The traps which made captures and the number of each species captured is recorded. The next morning the second “capture” visit is made to record over-night captures and to mark all unmarked animals before release. This process is repeated for a second 24 hour period, giving two day-time and two night-time capture periods.

The data recorded can be treated in a number of ways. Firstly, the number of marked animals plus unmarked captures in the last session represents the Minimum Number Alive (MNA), which is the simplest and most robust estimate of abundance for the SSU. However, by utilising the proportion of recaptures on the second day (a.m. and p.m.) it would be possible to obtain a

population estimate using a Capture-Mark-Recapture (CMR) method such as the Lincoln Index. (Southwood, 2000). Clearly, it would also be possible to reduce these capture data to PA-ratios, to augment data obtained from any Extensive live-trapping transects.

This method is only recommended for experienced volunteers who have been trained to handle and mark small mammals. It is also more time consuming than the other methods, requiring six visits over a 60 hour period – in total probably about eight hours work. However, the quality of data obtained is much higher than for the Extensive method and would allow greater sensitivity to detect change (see section 4.4 below).

4.2.3.6 *Owl pellet analysis – ancillary technique*

The Mammal Society's National Owl Pellet Survey has been running since 1993 and collects valuable information on the distribution of abundance of small mammal species across the UK. Although, a useful technique it does have some disadvantages (see 3.3.1) and is a hard technique to standardise across sites. As such it is not recommended as one of the main techniques in the survey design but volunteers will be made aware of the value of the owl pellet data and will be encouraged to submit owl pellets to the survey. The data collected during the Owl Pellet Survey can be compared to that collected in the Small Mammal Survey to determine if similar patterns in the population dynamics of small mammals are being detected. Volunteers with no prior experience of field surveys can contribute by collecting owl pellets that have been discarded at roost sites. Volunteers with an appropriate licence can collect owl pellets on a regular basis from nest boxes and contribute these to the survey.

4.2.4 **Number and location of SSUs within PSUs**

The number of SSUs and their locations is left largely to the choice of the volunteers. However, there are some constraints. Firstly, SSUs of the same type should be kept at least 250m apart, to ensure a large degree of ecological independence. Secondly, the type of SSU will be chosen to match the habitat and expertise of the volunteer. Clearly there will be no point in setting out a harvest mouse nest transect in woodland, for example.

This leaves a large number of possibilities for volunteers. Inexperienced volunteers, or those with little time, might choose just to carry out one or two harvest mouse nest and field vole sign transects in a single strip of rank grassland. Conversely, an experienced volunteer may decide to place a large number of intensive live-trapping transects in woodland and more along hedgerows and other field boundaries. They might also decide to carry out harvest mouse nest and field vole sign transects in all the rank grassland within their PSU. An illustration of how SSUs may be laid out within a PSU is given in Figure 17.

It is important, however, that the layout of the SSUs be as standard as possible. We feel that by constraining them to be 100m long transects, they will be small enough to fit into most patches of specific habitat, and flexible enough to be used in linear habitats (their flexibility is literal in that there is no reason why they cannot be set to follow meandering habitats such as field boundaries, woodland edges or riparian habitats.)

It is also important that the amount of effort expended on each type of SSU is kept fairly constant. By defining the size of the harvest mouse nest transects and proscribing 1m x1m square quadrats for the field vole sign transects, the amount of effort will be standardised. Furthermore, by providing a range of methods, taking between one and eight hours on-site, volunteers are not tempted to “cut corners”, as they might be with a single, more proscriptive method.

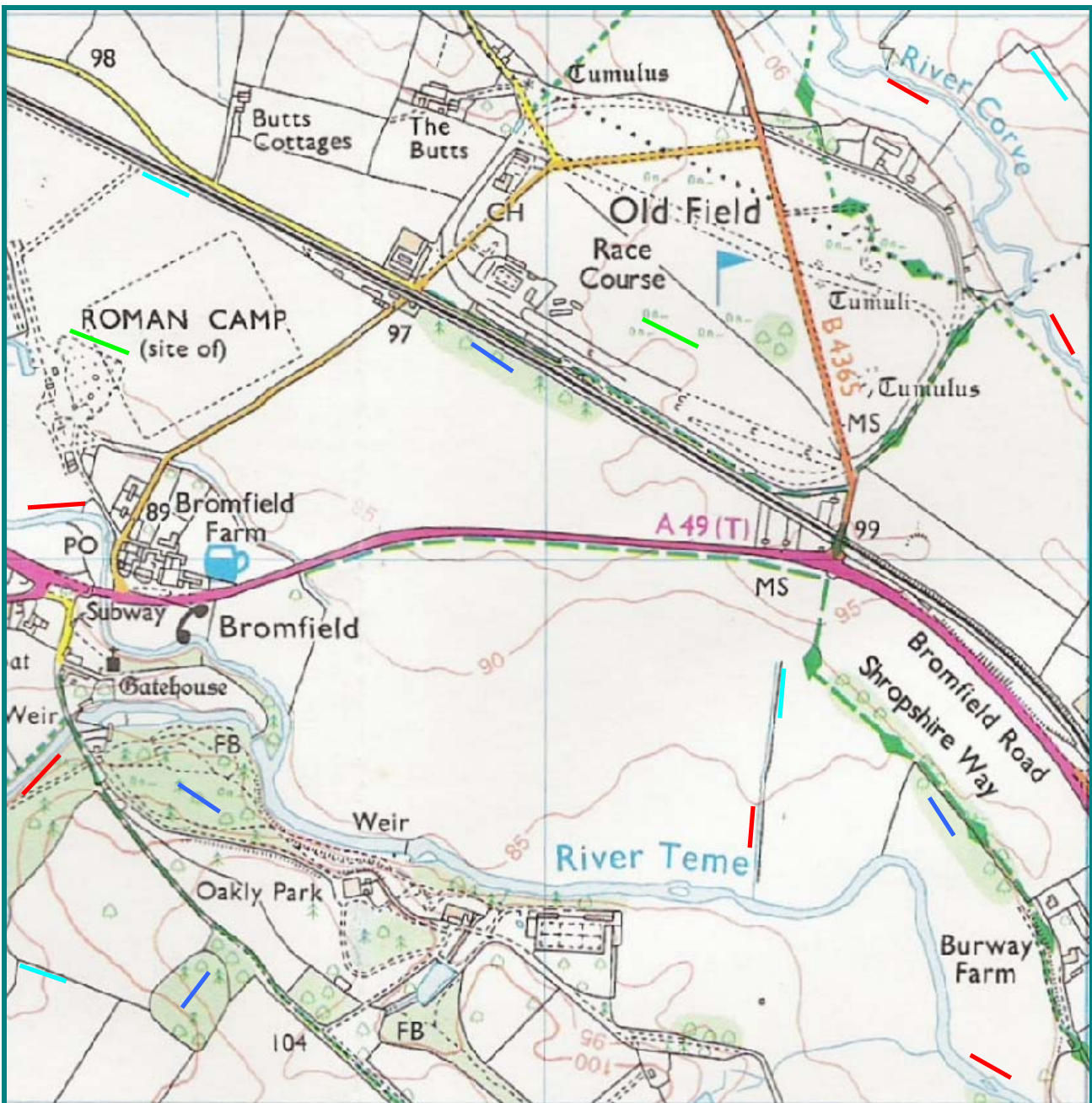

Figure 17. An example tetrad from mixed farmland in south Shropshire. This tetrad has a range of habitats, and is especially rich in riparian zones and linear features. This example shows two field vole sign transects (green, on the race course and roman camp), six bait tubes set for water shrews (red), four intensive live-trapping transects set in woodland (dark blue) and four intensive live-trapping transects set along field boundaries (light blue).

Reproduced from OS Explorer map (Ludlow, Tenbury Wells & Cleobury Mortimer) 1:25 000 scale by permission of Ordnance Survey on behalf of The Controller of Her Majesty's Stationery Office. © Crown copyright. All rights reserved. Licence number 100044328.

4.3 Temporal Factors

The periods of time that each type of SSU should be set for has been explained in section 4.2.3. At a larger temporal scale we recommend that monitoring be carried out during two, six-week windows:

- 1st May to 15th June.
- 15th November to 31st December.

For live trapping transects (and to a lesser extent bait tubes), the early summer period will largely sample the pre-recruitment breeding populations. It is likely to result in low capture rates, but they will probably be more stable over time. Conversely, the early winter period will predominantly capture the high proportion of young representing the post-breeding populations. This should give an indication of the variation in productivity over time.

The signs-based field methods are less influenced by the season as signs are more persistent. However, it is recommended that harvest mouse nests are only searched for during the winter period as they are easier to see when the vegetation has largely died back (Sargent & Morris, 2003).

4.4 Power Analysis

The purpose of a power analysis is to attempt, *a priori*, to estimate how large a sample will be required to test a null-hypothesis with a given degree of confidence and power. When the purpose of a study is simple, for example to estimate the size of a population of animals, in a clearly defined area such as a national park, at one point in time, then the power analysis is fairly straightforward. However, the primary aim of this study is to detect change over time, so we are immediately presented with two questions:

- How much change?
- Over what period of time?

Furthermore, as explained in section 4.2, it is difficult to design a multi-species survey which can obtain adequate data for all species. The same problem arises when attempting to ascertain sample sizes through power analysis. In particular, the intrinsic abundances will vary greatly between species, as will the between-site variance in abundances. In section 4.3 we have already alluded to the difference in numbers of animals present in the breeding and post-breeding populations, which for some species may be a factor of ten (Flowerdew *et al.*, 2004). And finally, certain species such as field voles are known to fluctuate on a multi-annual basis (Corbet & Harris, 1991; Mallorie & Flowerdew, 1994).

Consequently, it will not be possible to state exactly what sample size will enable us to detect desired degrees of change. The purpose of this section is to present the likely sample sizes that will be required under a range of circumstances, along with the factors which might influence them. In particular, this section will address the types of data which the survey design will yield and the rate of decline which can be detected from a likely range of values of these data.

4.4.1 Rates of Decline

The Tracking Mammals Partnership has agreed to adopt the **Amber** and **Red** levels of decline used for UK birds (Battersby, 2005). These represent a 25% and 50% decrease over 25 years, respectively. For the purposes of this power analysis, we will only address the detection of amber rates of decline. To do this, two assumptions will be made:

- Firstly, we will distinguish between an **amount of decrease** and a **rate of decline**. The amount of decrease is –25% from the starting value. In other words, if the population was 100 at time 0, then a 25% decrease would result in a population of 75 at time t .
- Secondly, the rate of decline will be based on a straight-line decline over 25 years. Consequently, this represents an annual decline of 1% of the starting value. It is also important to emphasise that this is a simple rate of decline not a compound rate. By making this assumption, it is possible to detect an **Amber Decline** over a shorter period than the full 25 years needed to detect a full **Amber Decrease**.

4.4.2 Types of data obtained

At the simplest level, each SSU can generate presence / absence data for each species. In other words, was a species recorded in an SSU during a particular season? However, the survey has been designed so that quantitative data can be obtained from all types of SSU during a season, as explained in section 4.2.3. These data are of two types:

- **Proportionate data** – the proportion of quadrats, tubes, traps, etc. which contained a species record.
- **Count data** – the number of harvest mouse nests, the MNA or a Lincoln Index estimate of population for each species.

Proportionate data follow a binomial distribution as they represent counts out of a maximum possible number. Thus, they are constrained between values of 0 and 1. However, we propose here that instead of calculating the proportion or percentage of FMUs with records, the data are presented as the ratio between the number of FMUs with records and the number without. For example, if five bait tubes in an SSU have water shrew droppings and five do not, then instead of calculating this as 50% “presence”, the data should be presented as a Presence-Absence ratio of 1. There are many statistical benefits in treating proportionate data in this way and it is proposed to use the term PA-ratio for these data. A full explanation of these concepts is beyond the scope of this report, but is being explored further by the authors.

It is important to recognise that the FMUs are not spatially independent of each other, so the data they generate may violate some of the assumptions of binomially distributed data. Furthermore, the resolution of the PA-ratios will differ depending on the number of FMUs. For example, if one bait tube is lost the PA-ratio will have to be calculated from a total of nine tubes. Similarly, if the data from an intensive live-trapping transect is to be presented as a PA-ratio, then it will have to be calculated from a total of 40 traps.

Another important issue arises with the two live-trapping transects. Assuming that the Longworth traps are mechanically perfect and only catch one animal at a time, the presence of a large number of one species may influence the number of a rarer species which can be caught. For example, if six of the ten traps are quickly filled with highly active wood mice, then this leaves only four traps for other species to occupy. We propose that the calculation of PA-ratios accounts for this by arbitrarily assuming that half the traps occupied by other species would have been available to the species in question. So, in the above example, if two of the traps captured bank voles, then the PA-ratio for wood mice would be 6:3 (6 with wood mice : 2 empty traps + half of 2 with bank voles) = 2 rather than 1.5. The PA-ratio for bank voles would be 2:5 (2 with bank voles : 2 empty traps + half of 6 with wood mice) = 0.4 rather than 0.25.

Two types of SSU, harvest mouse nest transects and intensive live-trapping transect, have been specifically designed to obtain count data. These data generally follow a Poisson distribution, although large counts tend towards a normal distribution. The relatively small size of the SSU, though, will tend to place an upper limit on the possible counts.

Data from these two types of SSU can also be calculated as PA-ratios. For example, if a number of bait tube transects have been placed in riparian habitats for water shrews, but a number of intensive live-trapping transects have also caught water shrews, it would be desirable to analyse a single variate for this species. By converting the trapping data to PA-ratios, a larger number of SSUs can contribute to the analysis than for each field method alone. (It may be necessary to include a factor to account for the SSU type during analysis).

4.4.3 The Simulations

The power analyses were undertaken using simulations. Again, a full description of the process is beyond the scope of this report and will be presented in a future document. Briefly, a large number of randomly generated datasets were analysed using generalized linear models. The models used either a binomial distribution with logit link-function (for PA-ratio data) or a Poisson distribution with log link-function (for count data). The stimulation data were derived with variations to four factors:

- **Sample size** ranging from 250 to 2,500 in seven discrete values.
- **Time period** ranging from 5 to 25 years in five-year intervals.
- **Mean value at time zero** of the variable. For PA-ratios these were set at 0.05 and 0.5 and for counts they were 2 and 20.
- **Rate of decline** of the variable. For both types of data, these were 27%, 28% and 30%.

These variations represent the likely range of values which would be obtained. For example, in recent volunteer based mammal surveys, the number of sites ranged from 240 field-signs based sites in the third year of the Winter Mammal Monitoring programme (Noble *et al.*, 2005) to 803 sightings-based sites in the first year of the programme. In the recent Mammal Society Water Shrew Survey (Carter & Churchfield, 2005), 2071 sites were surveyed. Time periods ranged from the minimum reasonable for a monitoring programme (5 years) to the period defined for the amber and red alerts discussed above. The mean values at time zero can obviously range very widely (see e.g. Noble *et al.*, 2005) for numbers of sightings and proportions of sections with field signs) and the starting values have been chosen to reflect this. Finally, the rates of decline have been chosen based on the detection of amber declines.

The null-hypothesis tested with these models is that the rate of decline is not significantly greater than 25%. Note that this is a one-tailed test, where only greater declines are of interest. In other words, what is the probability that, given the variations in the four factors described above, the observed rate of decline is at least an amber rate of decline? The simulations represent the simplest type of analysis which could be undertaken with data derived from a monitoring programme, where only one predictive variable (time) is of interest.

4.4.4 Power analysis for PA-ratios

The data for the power analysis of PA-ratios were drawn from binomial distributions based on ten trials only and with the probability of success set to 0.05 or 0.5. Figure 18 shows the probability of detecting an amber rate of decline with PA-ratios for the different values of the four factors described above. So, for example, the top left graph shows the probabilities when the observed rate of decline in the sample is 27% and the PA-ratio in Year 0 is 0.05. Only two traces appear on the graph, representing monitoring periods of 20 and 25 years. The latter trace shows that with a sample size of 2500, the probability of the observed rate of decline being at least an amber rate is approximately 0.1, i.e. not significant at $\alpha = 0.05$. With smaller sample sizes and with shorter time periods, the α -value increases, representing lower levels of significance. So this graph shows that if the observed rate of decline from a starting value of 0.05 is only 27%, then the full 25 years with a sample of at least 4000 will be required to achieve a significant result.

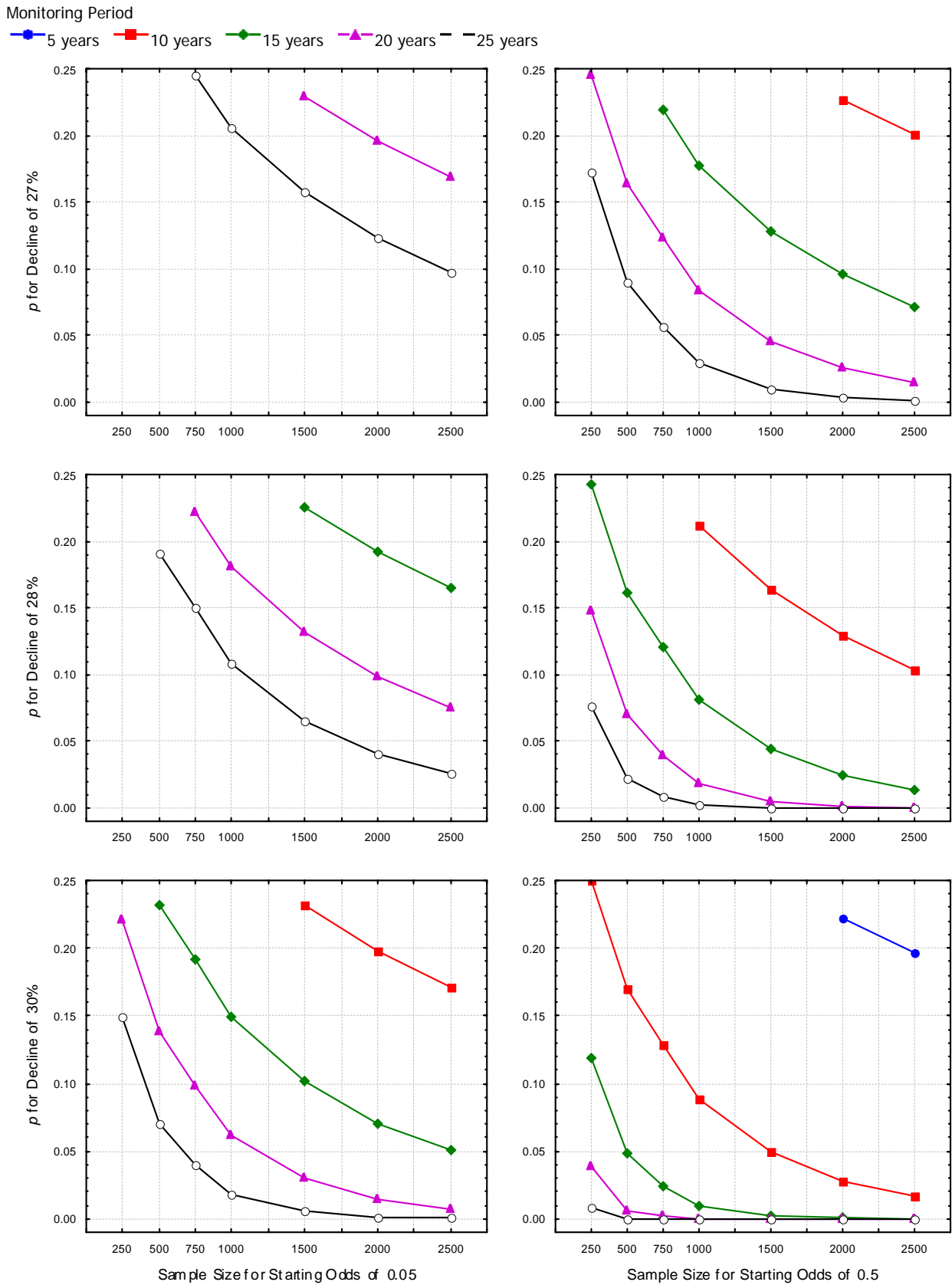

Figure 18. The probability of detecting an amber rate of decline (25%) with proportionate data. Each graph shows the probabilities based on seven different sample sizes over five time periods. The left hand column of graphs shows declines based on mean starting odds of 0.05 (approximately 4.75%), with the right-hand column based on mean starting odds of 0.5% (approximately 33%). The rows show the probabilities based on three observed rates of decline in the sample (27%, 28% and 30%).

This figure also shows the effect of greater rates of decline. The middle-left graph shows the probabilities when the rate of decline is 28% and the lower-left graph when it is 30%. The former shows that over a 25 year period a sample size of around 2000 would probably be sufficient to achieve a significant result. The lower graph shows that a sample size of only 750 would achieve significance over a period of 25 years. Moreover, a sample of 1500 would show a significant result after 20 years and a sample of slightly more than 2500 could show a significant result after 15 years. Note, however, that even this level of decline cannot show an amber rate of decline in less than 15 years, even with a sample size of 2500.

Figure 18 also shows the effect of the intrinsic magnitude of the data. The three graphs on the right-hand side show mean starting PA-ratios of 0.5, which represents ten times the odds of finding water shrew scats, for example, than the left-hand graphs. Clearly this greatly increases the power of the sample to achieve significance. So, even with an observed decline of only 27%, a sample of 1500 could achieve significance after 20 years. With an observed decline of 30%, very small samples of 250 would be significant over a 20 year period and, conversely, samples of 2000 could achieve significance in as little as ten years. Note, however, that even with these favourable factors, a 5-year period would still require a sample of many thousands to be useful.

4.4.5 Power analysis for Count data

The influence of these four factors (see section 4.4.3) on count data is displayed in Figure 19. Here the data were drawn from Poisson distributions with means of 2 and 20. It turns out that these arbitrarily chosen values give more power to detect change than the two chosen PA-ratios, but this, in itself, is of no importance. So, if a decline of 27% is recorded in a sample with a mean starting count of 2, a sample size of a little over 1000 would achieve a significant result after 25 years. An observed decline of 30% with the same starting value could achieve a significant result with a sample of 2500 in around 10 years.

With the larger mean starting count of 20, significant results can be achieved with relatively small sample sizes over reasonably short periods of time. If a decline of 30% is recorded in a sample of 2500, then this could show a significant result in less than five years. Conversely, a very small sample would be required if the monitoring could be carried out for more than ten years.

4.4.6 Discussion

It is important to point out the limitations and assumptions of these simulations. Firstly, they assume perfect sampling conditions so that exactly the same sample size is achieved every year. Statistical models will be less powerful if the sample changes year-on-year.

Secondly, the models assume that the samples have been drawn independently each year; in other words, no site is visited more than once. In most monitoring programmes, this is not usually the case, as volunteers are encouraged to revisit the same site for as many years as possible. Such a monitoring strategy can allow greater power during analysis as the variation between sites can be excluded from the testing of change over time. This means that the results from the simulation can probably be “improved” (smaller sample sizes, shorter periods, etc.) if repeat-visit data are obtained. However, there can be serious problems with site or volunteer turnover, which tends to negate these advantages (Noble *et al.*, 2005).

Thirdly, these models assume only single-stage sampling. In other words, in the previous sections, a sample size of 2500 means 2500 independent PSUs, each of which yields only one datum, such as a count (MNA) of wood mice. However, the survey design proposed here uses two-stage sampling. This means that if each PSU contains a number of SSUs, each yielding one datum, the total number of cases in the dataset may be much larger. The important question here is, “Is a sample of 250 PSUs each with 10 SSUs better or worse than a sample of 2500 PSUs

with only one SSU each?”. The answer to this is that it depends on the inter-site variation compared to the intra-site variation. If this is assumed to be the same, then it makes no difference and the current simulations can be used. However, if the inter-site variation is relatively large then two-stage sampling can result in a more powerful model, and the results from the simulations can be considered conservative. If the opposite is true, then two-stage sampling may reduce the power. However, this is usually offset by the much cheaper cost of gathering a given amount of data from a two-stage sampling programme.

Finally, the whole question of inter-site variation has not been addressed. The simulated data follow the basic distributions from which they are drawn. However, in the real world, populations of small mammals do not follow such theoretical distributions. For example, ubiquitous species such as wood mice may be found in regular numbers in many sites throughout the country. This would result in a lower inter-site variation than used in the simulations, so the results can be treated as conservative. However, for habitat specialists, the opposite may be true and the resultant data would be over-dispersed. The result of this is that larger samples or longer periods may be required to achieve significant results.

This summary raises many issues about the efficacy of power analysis. However, a full discussion of these issues is beyond the scope of this report and the authors are currently developing simulations using repeat-visit data, with different inter-site variation.

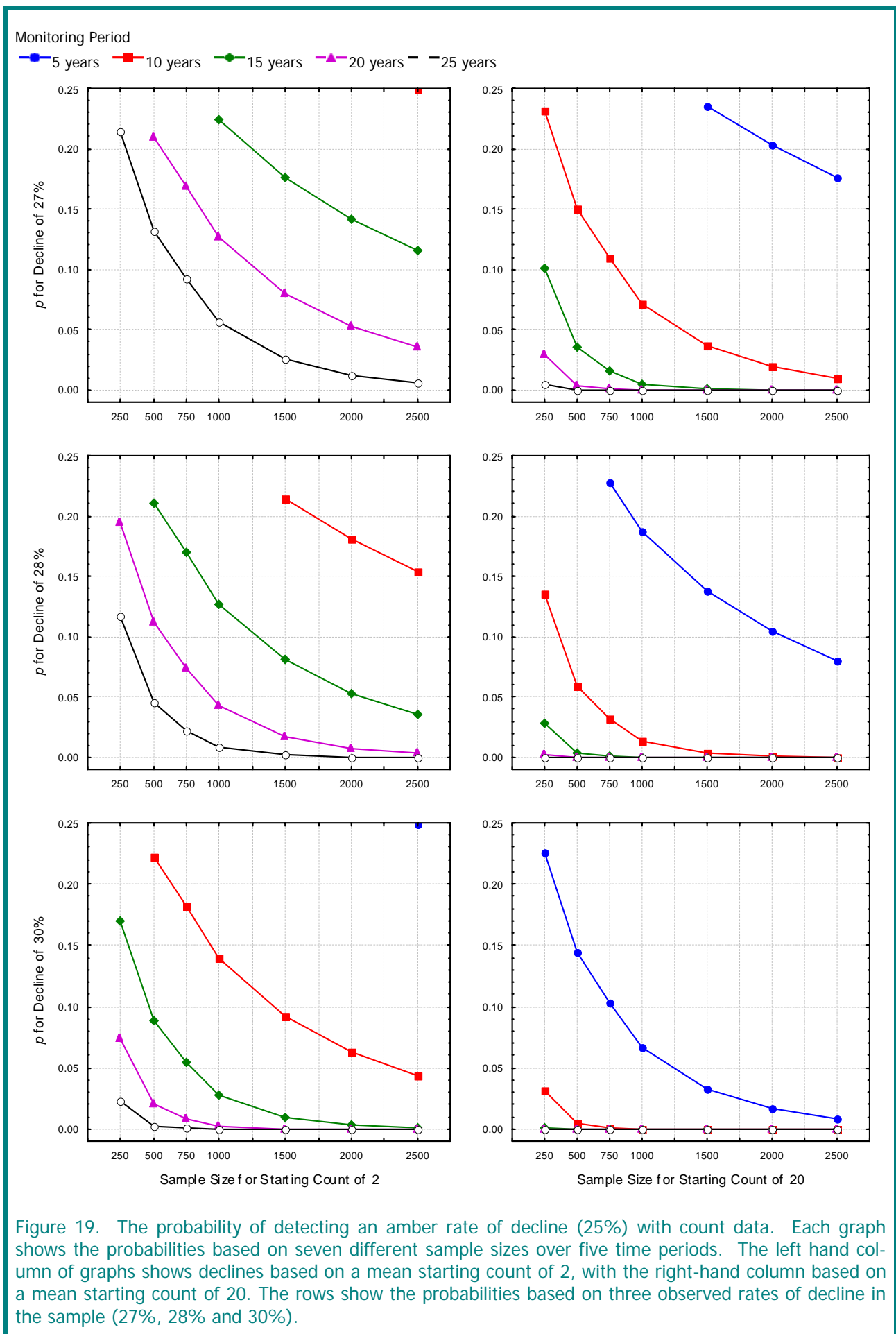

4.5 Summary

We believe that the survey design proposed in this chapter has a number of major advantages for use in a national, volunteer-based survey. Broadly they fall into two categories; statistical and volunteer-based.

4.5.1 Statistical Advantages

The sampling strategy uses a simple randomised sampling scheme, which assures a representative and objectively derived sample. This means that resultant statistics should be unbiased and can be extrapolated to the population as a whole.

The Primary Sampling Units are standardised as Ordnance Survey tetrads covering 4km².

Furthermore, the Secondary Sampling Units have also been standardised in size, and as far as possible in the number of Field Method Units that they contain. This means that the data derived from them have standard properties, even when the method itself varies between different SSU types.

4.5.2 Advantages for Volunteers

The main aim of the survey design has been to devise an overall methodology which gives volunteers a wide range of choices. This means that volunteers with a range of expertise can take part in the survey, choosing a method to match their expertise level. Furthermore, these methods involve different amounts of effort, so again a choice can be made by the volunteer about how long they want to spend doing the survey. Despite this, the individual methods are standardised so that a single method type ensures fairly constant effort.

We have shown that by using a 4% sampling fraction with O.S. tetrads as the Primary Sampling Units, volunteers are highly likely to have a PSU within 10km of their home. Even if the first choice tetrad is not suitable a second is likely to be available within, on average, only another 2.5km.

The Secondary Sampling Units have been designed as a standard length (100m) transect with a standard number of points. This makes locating and setting out the SSUs simpler. Transects can be laid along linear features as well as within two-dimensional areas of, say, woodland or grassland. Furthermore, they do not have to be straight, but can follow meandering routes such as streams or field boundaries.

The extensive live-trapping method, allows less experienced volunteers to undertake live-trapping with a small number of traps and without the necessity to handle and mark the captured animals. It also has a short field period, meaning that the whole process can be carried out over a weekend.

It should be pointed out that more detailed instructions would be given to volunteers in their survey packs than we have presented here. Different terminology would also be used, such as Site for PSU and Transect for SSU etc.

5 Recommendations

The recommendations we present here address two main scenarios:

- Firstly, we propose that a small-scale pilot scheme be run over a 2-year period. This is primarily to test the field methodologies and obtain sample data for the power analyses to estimate sample sizes.
- Secondly, we make recommendations for a nationwide Small Mammal Monitoring programme to be run on an annual basis for an unlimited time period.

5.1 Two-Year Pilot Scheme

The pilot scheme will use a small team of between ten and twenty expert volunteers. They will be committed to undertaking a minimum of five sites each, for at least one summer and one winter period. We propose a two-year period beginning April 2006 until March 2008. If funding can be agreed quickly enough, this should allow some sites to be covered in the first summer period (May/June), giving two summer and two winter periods in total. The use of experts will preclude a requirement for training, and should provide adequate Longworth traps (in conjunction with The Mammal Society's trap-loan scheme).

The scheme will obtain data on:

- The length of time required for each field method, their ease of use and suitability for a range of volunteer expertise.
- The effect of altering the length of transects and /or the number of field method units.
- Expected ranges of data values obtained for each species using the proscribed methods
- Inter-season and inter-year variation in captures/records.
- Possible inter-observer biases.
- The range and resolution of habitat information required.

5.1.1 Costings

The estimated costings given in Table 4 are based on a 2.5% increment in staff costs and some direct running costs in the second year to account for inflation.

Note: These costs are estimates only, for the purposes of illustration, and should not be taken as a fixed quotation.

Table 4. Annual Costings for 2 Year Pilot Study

	Year 1		Year 2	
	Unit costs	Units	Unit costs (+2.5%)	Units
Staff & Consultancy				
Project Officer				
Support Staff				
Consultant Statistician				
Consultant Database Designer				
Consultant Ecologist (scat analysis)				
Totals				
Direct Running Costs				
Project Officer expenses & running costs				
Volunteer expenses				
Production & dissemination of information packs				
Production of Final Report				
Totals				
Equipment and Materials				
Bait tubes & muslin				
Quadrats				
Replacement Longworth Traps				
Totals				
Total Costs				

Confidential

5.2 National Small Mammal Monitoring Programme

The National Small Mammal Monitoring Programme would be run on an annual basis. We would propose a group of local co-ordinators, which will probably be based on the team of expert volunteers that undertook the pilot scheme. From our experiences running the Winter Mammal Monitoring Programme, we anticipate approximately 1,000 volunteers carrying out the simpler field methods, of which 250 would be involved with live-trapping.

5.2.1 Costings

The following estimated costs are based on one organisation running the scheme, for an initial period of ten years. The costings are broken down into the start-up year, eight interim years and a final year, which would have additional reporting costs. Staff costs, expenses and training costs have been incremented 2.5% annually to account for inflation, so the interim years are average figures over the eight-year period.

The cost of Longworth traps is clearly the major capital item at the outset of the project. We estimate that 4,000 traps would be sufficient. These would be lent on a short-term basis to volunteers; 200 volunteers with 10 traps each and 50 with 40 each. Clearly, this outlay is essential in year one but, with a small annual replacement, they could be amortised over the ten-year life of the project.

Note: These costs are estimates only, for the purposes of illustration, and should not be taken as a fixed quotation.

Table 5. Annual Costings for On-going Ten-year Monitoring Programme

	Year 1			Years 2 - 9			Year 10		
	Unit Costs	Units	Outgoings	Unit Costs	Units	Outgoings	Unit Costs	Units	Outgoings
Staff & Consultancy									
Project Officer									
Support Staff									
Consultant Statistician									
Consultant Database Designer									
Consultant Ecologist (scat analysis)									
Totals									
Direct Running Costs									
Project Officer expenses & running costs									
Management costs (CEO or Council time/expenses)									
Co-ordinator expenses									
Production of publicity fliers									
Production of information packs									
Production of annual newsletter									
Production of volunteer returns									
Stationary and postage									
Expenses for Steering Group									
Production of Final Report									
Totals									
Training Courses									
Venue and trainer costs									
Handouts, Trainers packs, Resources									
Fees charged to Volunteers									
Totals									
Equipment and Materials									
Bait tubes & muslin									
Quadrats, etc									
Initial purchase of Longworth Traps (incl Vat)									
Annual replacement of traps									
Postage / carriage for equipment									
Totals									
Total Costs									
Total costs with Longworth Traps amortised over life-time of project									

Confidential

6 Acknowledgements

This contract was funded by the JNCC. We would like to thank the administrator of the contract, Dr Jessamy Battersby, for her support and encouragement.

The Mammal Society is very grateful to all the Mammal Groups, Wildlife Trusts and other individuals who participated in the questionnaire survey and who were contacted for their advice. Derek Yalden, John Flowerdew, Sara Churchfield and Georgette Shearer all made useful comments on the draft report for which we are very grateful.

7 References

- Aybes, C. & Sargent, G. (1997) *Investigation into survey techniques for recording Water Shrews (Neomys fodiens)*. Report to World Wildlife Fund (UK). The Mammal Society, London.
- Andrzejewski, R., Bujalska, G., Ryszkowski, L. & Ustyniuk, J. (1966) On the relation between the numbers of traps in a point of catch and trappability of small rodents. *Acta Theriologica* **11**: 343-349.
- Andrzejewski, R. & Rajksa, E. (1972) Trappability of bank voles in pitfalls and live traps. *Acta Theriologica* **17**: 41-56.
- Aplin, K. P., Brown, P. R., Jacob, J., Krebs, C. J. & Singleton, G. R. (2003) *Field methods for rodent studies in Asia and the Indo-Pacific.*, Australian Centre for International Agricultural Research, CSIRO, Australia.
- Baker, P. J., Ansell, R. J., Dodds, P. A. A., Webber, C. E. & Harris, S. (2003) Factors affecting the distribution of small mammals in an urban area. *Mammal Review* **33**: 95-100.
- Battersby, J. E. & Greenwood, J. J. (2004) Monitoring Terrestrial Mammals. *Mammal Review* **34**: 3-29.
- Battersby, J. (Ed) & Tracking Mammals Partnership. (2005) *UK Mammals: species Status and Population Trends. First Report by the Tracking Mammals Partnership.* JNCC / Tracking Mammals Partnership, Peterborough.
- Barnett, A. & Dutton, J. (1995) *Expedition Field Techniques, Small Mammals (excluding bats)*, Expedition Advisory Service, London.
- Bellamy, P. E., Shore, R. F., Ardeshir, D., Treweek, J. R. & Sparks, T. H. (2000) Road verges as habitats for small mammals in Britain. *Mammal Review* **30**: 131-143.
- Bence, S., Stander, K. & Griffiths, M. (1999) Nest site selection by the harvest mouse (*Micromys minutus*) on arable farmland. *Aspects of Applied Biology* **54**: 197-202.
- Bence, S., Stander, K. & Griffiths, M. (2003) Habitat characteristics of harvest mouse nests on arable farmland. *Agricultural Ecosystems & Environment* **99**: 179-186.
- Birks, J. (2002) *The Pine Marten*. The Mammal Society, London
- Boonstra, R. & Krebs, C. J. (1978) Pitfall trapping of *Microtus townsendii*. *Journal of Mammalogy* **59**: 136-148.
- Boonstra, R. & Rodd, F. H. (1982) Another potential bias in the use of the Longworth trap. *Journal of Zoology* **63**: 673-675.
- Brown, K. P., Moller, H., Innes, J. & Alterio, N. (1996) Calibration of tunnel tracking rates to estimate relative abundance of ship rats (*Rattus rattus*) and mice (*Mus musculus*) in a New Zealand forest. *New Zealand Journal of Ecology* **20**: 271-275.
- Brown, L. E. (1969) Field experiments on the movements of *Apodemus sylvaticus* L. using trapping and tracking techniques. *Oecologia* **2**: 198-222.
- Buckley, J. (1977) Barn Owl predation on the Harvest Mouse. *Mammal Review* **7**: 117-121.
- Bunn, D. S., Warburton, A. B. & Wilson, R. D. S. (1982) *The barn owl*. Poyser, London.
- Catling, P. C., Burt, R. J. & Kooyman, R. (1997) A comparison of techniques used in a survey of the ground-dwelling and arboreal mammals in forests in North-eastern New South Wales. *Wildlife Research* **24**: 417-432.
- Carey, A. B. Biswell, B. L. & Witt, J.W. (1991) *Methods for measuring the abundance of arboreal rodents*. USDA Forest Service, technical report, Oregon.

- Carter, P. K. L. & Churchfield, S. (2005) *The distribution and habitat occurrence of water shrews (Neomys fodiens) in Great Britain*. Preliminary report to Environment Agency. The Mammal Society, London.
- Churchfield, S. (1984) Dietary separation in three species of shrews inhabiting water-cress beds. *Journal of Zoology* **204**: 229-240.
- Churchfield, S. (1986) *Shrews*. Anthony Nelson Ltd., Oswestry.
- Churchfield, S. (1990) *The Natural History of Shrews*. Christopher Helm, A & C Black, London.
- Churchfield, S., Barber, J. & Quinn, C. (2000) A new survey method for water shrews (*Neomys fodiens*) using baited tubes. *Mammal Review* **30**: 249-254.
- Corbet, G.B. & Harris, S. (Eds) (1991) *The Handbook of British Mammals*. Third edition. Blackwell Scientific Publications, Oxford.
- Corbet, G. B. & Southern, H. N. (Eds) (1977) *The Handbook of British Mammals*. Second edition. Blackwell Scientific Publications, Oxford.
- Delany, M. J. (1974) *The Ecology of Small Mammals*. The Camelot Press Ltd., Southampton.
- Dickman, C. R. (1986) A method for censusing small mammals in urban habitats. *Journal of Zoology* **210**: 631-633.
- Flowerdew, J. R. (1984) *Woodmice*. The Mammal Society, London.
- Flowerdew, J. R. (2004) Advances in the conservation of British Mammals, 1954-2004: 50 years of progress with The Mammal Society. *Mammal Review* **34**: 169-210.
- Flowerdew, J. R., Shore, R. F., Poulton, S. M. C. & Sparks, T. H. (2004) Live Trapping to Monitor Small Mammals in Britain. *Mammal Review* **34**: 131-150.
- Garland, L. (2002) *Microhabitat selection by small mammals on grassy road verges*. Unpublished PhD thesis, University of Bristol.
- Garson, P. J. & Lurz, P. W. W. (1998) *Red squirrel monitoring: the potential of hair tubes for estimating squirrel abundance in conifer plantations dominated by sitka spruce*. Report on Contract 76-01-68. JNCC, Peterborough.
- Genoud, M. (1978) Etude d'une population urbaine de musraignes musettes (*Crocidura russula* Herman, 1789), *Bulletin de la Societe Vaudoise des Sciences Naturelles* **74**: 25-34.
- Glue, D. E. (1967) Prey taken by the barn owl in England and Wales. *Bird Study* **14**: 169-183.
- Glue, D. E. (1971) Avian predator pellet analysis and the mammalogist. *Mammal Review* **21**: 200-210.
- Glue, D. E. (1974) Food of the barn owl in Britain and Ireland. *Bird Study* **21**: 200-210.
- Glue, D. E. (1977) Breeding biology of Long-eared Owls. *British Birds* **70**: 318-331.
- Godfrey, G. K. (1978a) The activity pattern in white-toothed shrews (*Crocidura suavolens* and *Sorex araneus fretalis*) in Jersey. *Journal of Zoology* **185**: 266-270.
- Godfrey, G. K. (1978b) The activity pattern in white-toothed shrews studied with radar. *Acta theriologica* **23**: 381-390.
- Gorman, M. L. & Reynolds, P. (1993) The impact of changes in land use on voles and raptors. *Mammal Review* **23**: 121-126.
- Greenwood, A., Churchfield, S. & Hickey, C. (2002) Geographical distribution and habitat occurrence of the Water Shrew (*Neomys fodiens*) in the Weald of South-East England. *Mammal Review* **32**: 40-50.

- Gurnell, J. & Langbein, J. (1983) Effects of trap position on the capture of woodland rodents. *Journal of Zoology* **200**: 289-292.
- Gurnell, J. & Flowerdew, J. R. (1990) *Live Trapping Small Mammals: A Practical Guide*. Second edition. The Mammal Society, London.
- Gurnell, J. & Flowerdew, J. R. (2006) *Live Trapping Small Mammals: A Practical Guide*. Fourth edition. The Mammal Society, London.
- Gurnell, J., Hicks, M. & Whitbread, S. (1992) The effects of coppice management on small mammal populations. In: *Ecology and Management of Coppice Woodlands* (Ed. by G.P. Buckley), pp. 213-232. Chapman & Hall, London.
- Gurnell, J., Lurz, P. W. W. & Pepper, H. (2001). *Practical techniques for surveying and monitoring squirrels*. Practice Note 11. Forestry Commission Alice Holt.
- Haines-Young, R. H., Barr, C. J., Black, H. I. J., Briggs, D. J., Bunce, R. G. H., Clarke, R. T., Cooper, A., Dawson, F. H., Firbank, L. G., Fuller, R. M., Furse, M. T., Gillespie, M. K., Hill, R., Hornung, M., Howard, D. C., McCann, T., Morecroft, M. D., Petit, S., Sier, A. R. J., Smart, S. M., Smith, G. M., Stott, A. P., Stuart, R. C. & Watkins, J. W. (2000) *Accounting for nature: assessing habitats in the UK countryside*. DETR, London ISBN 1 85112 460 8
- Hansson, L. (1979) Field signs as indicators of vole abundance. *Journal of Applied Ecology* **16**: 339-349.
- Hansson, L. & Hoffmeyer, I. (1973) Snap and live trap efficiency for small mammals. *Oikos* **21**: 255-266.
- Harris, S. (1979) History, distribution and habitat requirements of the Harvest Mouse in Britain. *Mammal Review* **9**: 159-171.
- Harris, S., Morris, P., Wray, S. & Yalden, D. (1995) *A Review of British Mammals: Population Estimates and Conservation Status of British Mammals other than Cetaceans*. Joint Nature Conservation Committee, Peterborough.
- Harris, S. & Yalden, D. W. (2004) An integrated monitoring programme for terrestrial mammals in Britain. *Mammal Review* **34**: 157-167.
- Hasler, N., Klette, R., Rosenhahn, B. & Agnew, W. (2004) Footprint recognition of rodents and insects. In: *Image and Vision Computing 2004* (Ed. by D. Pariman, H. North and S. McNeill), pp. 167-172. Landcare Research Ltd. Akaroa, New Zealand.
- Hice, L. C. & Schmidly, D. J. (2002) The effectiveness of pitfall traps for sampling small mammals in the Amazon Basin. *Mastozoologia Neotropical* **9**: 85-89.
- Jacob, J., Ylönen, H., & Hodkinson, C. G. (2002) Trapping efficiency of Ugglan traps and Longworth traps for house mice in south-eastern Australia. *Wildlife Research* **29**: 101-103.
- Jaksic, F. M., Torres-Mura, J. C., Cornelius, C. & Marquet, P. A. (1999) Small mammals of the Atacama Desert (Chile). *Journal of Arid Environments* **42**: 129-135.
- Jones, C., McShea, W. J., Conroy, M. J. & Kunz, T. H. (1996) In: *Measuring and monitoring biological diversity: standard methods for mammals* (Ed. by D. E. Wilson, F. R. Cole, J. D. Nichols, R. Rudran & M. S. Foster). p115-155. Smithsonian Institution Press, Washington, D.C.
- King, C. M., Martin, R. D., McDonald, R. M., Tempero, G., Dekrout, A., Holmes, S. & Stirnemann, M. (2005) *Automated monitoring of small animals*. Conference paper, 13th Australasian Vertebrate Pest Control Conference, Wellington, New Zealand.
- Kitchener, A. (1995) *The Wildcat*. The Mammal Society, London.
- Krebs, C. J. (1989) *Ecological Methodology*. Harper Collins, NY.

- Kotzageorgis, G. C. & Mason, C. F. (1997) Small mammal populations in relation to hedgerow structure in an arable landscape. *Journal of Zoology* **242**: 425-434.
- Lambin, X. & MacKinnon, J. (1997) The relative efficiency of two commercial live traps for small mammals. *Journal of Zoology* **242**: 400-404.
- Lambin, X., Petty, S. J. & Mackinnon, J. L. (2000) Cyclic dynamics in field vole populations and generalist predation. *Journal of Animal Ecology* **69**: 106-118.
- Langton, S. D., Cowan, D. P. & Meyer, A. N. (2001) The occurrence of commensal rodents in dwellings as revealed by the 1996 English House Condition Survey. *Journal of Applied Ecology* **38**: 699-709.
- Lindenmayer, D. B., Incoll, R. D., Cunningham R. B., Pope M. L., Donnelly C. F., Macgregor, C. I., Tribolet, C. & Triggs, B. E. (1999) Comparison of hair tube types for the detection of mammals. *Wildlife Research* **26**: 745-750.
- Little, J. & Gurnell, J. (1989) Shrew capture and rodent field studies *Journal of Zoology* **218**: 329-331.
- Lord, R. D., Vilches, A. M., Maiztegui, J. I. & Soldini, C.A. (1970) The tracking board: a relative census technique for studying rodents. *Journal of Mammalogy* **51**: 828-829.
- Love, R. A., Webbon, C. C., Glue, D. E. & Harris, S. (2000) Changes in the food of British Barn Owls (*Tyto alba*) between 1974 and 1997. *Mammal Review* **30**: 107-129.
- Love, R. A. (2005) *The Mammal Society National Owl Pellet Survey*. The Mammal Society, London.
- Macdonald, D. W, Mace, G. & Rushton, S. P. (1998). *Proposals for the Future Monitoring of British Mammals*. DETR, London.
- Macdonald, D. W. & Tattersall, F. (2001) *Britain's Mammals: The Challenge for Conservation*. People's Trust for Endangered Species, London.
- McDonald, R. & Harris, S. (1998) *Stoats and Weasels*. The Mammal Society, London
- Maddock, A. D. (1992) Comparison of two methods for trapping rodents and shrews. *Israeli Journal of Zoology* **38**: 333-340.
- Magris, L. & Gurnell, J. (2000) *The Jersey Mammal Survey*. Unpublished report for the Planning and Environment Committee, States of Jersey.
- Mallorie, H. C. & Flowerdew, J. R. (1994) Woodland small mammal population ecology in Britain: a preliminary review of The Mammal Society survey of woodmice *Apodemus sylvaticus* and bank voles *Clethrionomys glareolus*, 1982-87. *Mammal Review* **24**:1-15.
- Marsh, A. C. W. (1999) *Factors determining the range and abundance of the yellow-necked mouse (Apodemus flavicollis) in Great Britain*. Ph.D. Thesis, University of Bristol.
- Marsh, A. C. W., Poulton, S. M. C. & Harris, S. (2001) The yellow-necked mouse in Britain: status and analysis of factors affecting distribution. *Mammal Review* **31**: 203-227.
- McCay, T. S., Laerm, J., Menzel, M. A. & Ford, W. M. (1998) Methods used to survey shrews (Insectivora: Soricidae) and the importance of forest floor structure. *Brimleyana* **25**: 110-119.
- McManus, J. J. & Nellis, D.W. (1972) Relative efficiencies of four small mammal traps, *Journal of Mammalogy* **4**: 868-872.
- Michielsen, N. C. (1966) Intraspecific and interspecific competition of the shrews *Sorex araneus* L. and *Sorex minutus* L. *Archives Nerlandaises de Zoologie* **17**: 73-174.

- Mills, D. J., Harris B., Claridge, A. W. & Barry, S. C. (2002) Efficacy of hair-sampling techniques for the detection of medium-sized terrestrial mammals - A comparison between hair-funnels, hair-tubes and indirect signs. *Wildlife Research* **29**: 379-387.
- Montgomery, W. I. (1978) Studies on the distribution of *Apodemus sylvaticus* (L.) and *A. flavicollis* (Melchior) in Britain. *Mammal Review* **8**: 177-184.
- Montgomery, W. I. (1980) Population structure and dynamics of sympatric *Apodemus* species (Rodentia: Muridae). *Journal of Zoology* **192**: 351-377.
- Moore, N. P., Askew, N. & Bishop, J. D. (2003) Small mammals in new farm woodlands *Mammal Review* **33**: 101-104.
- Morris, R. D. (1968) A comparison of capture success between Sherman and Longworth live traps. *The Canadian Field Naturalist* **82**: 84-87.
- National Federation of Badger Groups (2004) *Bovine TB in Cattle*. NFBG briefing paper, NFBG, London
- Morris, P. A. (1993) *A Red Data Book for British Mammals*. The Mammal Society, London.
- Noble, D., Carter, P., Harris, S., Leech, D., Poulton, S. & Shearer, G. (2005) *Winter Mammal Monitoring - a pilot study*. BTO Research Report 410 & The Mammal Society Research Report 5. BTO, Thetford & The Mammal Society, London.
- O'Farrell, M. J., Clark, W. A., Emmerson, F. H., Juarez, S. M., Kay, F. R., O'Farrell, T. M. & Goodlett, T. Y. (1994) Use of mesh live traps for small mammals: are results from Sherman live traps deceptive? *Journal of Mammalogy* **75**: 692-699.
- Pernetta, J. C. (1973) The ecology of *Crocidura suaveolens cassiteridum* (Hinton) in a coastal habitat. *Mammalia* **37**: 241-256.
- Pernetta, J. C. (1977) Population ecology of British shrews in grassland. *Acta theriologica* **22**: 279-296.
- Perrow, M. R. & Jordan, M. J. R. (1992) *The influence of agricultural land use upon populations of harvest mouse (Micromys minutus Pallas)*. Report to TERF, Hoechst UK, East Winch, Norfolk.
- Perrow, M. & Jowitt, A. (1995) What future for the Harvest Mouse? *British Wildlife* **6**: 356-365.
- Pocock, M. & Jennings, N. (in preparation) Use of hair tubes to survey for shrews in Britain: new methods for identification and quantification of abundance.
- Pollard, E. & Relton, J. (1970) A study of small mammals in hedges and cultivated fields. *Journal of Applied Ecology* **7**: 549-57.
- Poulton, S. (1990) *The National Survey of Small Mammals in Hedgerows. Trapping Results 1983 – 1989*. ADAS Unpubl. Report.
- Powell, R. A. & Proulx, G. (2003) Trapping and marking terrestrial mammals for research: integrating ethics, performance criteria, techniques, and common sense. *Laboratory Animal Research Journal* **44**: 259-267.
- Pucek, Z. (1969) Trap response and estimation of numbers of shrews in removal catches. *Acta Theriologica* **14**: 403-426.
- Redpath, C. J., Thirgood, S. J. & Redpath, S. M. (1995) Evaluation of methods to estimate field vole abundance in the uplands. *Journal of Zoology* **237**: 49-57.
- Rood, J. P. (1965) Observations on the home range and activity of the Scilly shrew. *Mammalia* **29**: 507-516.

- Roscrow, L. M. (2005) Comparing relative density of UK *Apodemus* species in two Hampshire woodlands, and comparing efficacy of two commercial small mammal live traps. Unpublished BSc thesis, University of Portsmouth.
- Sanecki, G. M. & Green, K. (2005) A technique for using hair tubes beneath the snowpack to detect winter-active small mammals in the subnivean space. *European Journal of Wildlife Research* **51**: 41-47.
- Sargent, G. (1999) *The Mammal Society's Report on Look Out for Mammals 1996-1999*. The Mammal Society, London.
- Sargent, G. (1999) Harvest Mouse in Trouble. *Mammal News* **111**: 1.
- Sargent, G. & Morris, P. (2003) *How to Find and Identify Mammals*. The Mammal Society, London.
- Scottish Natural Heritage (2005) *The Orkney Vole – A Management Guide*. Scottish Natural Heritage.
- Scotts, D. J. & Craig, S. A. (1988) Improved hair sampling tube for the detection of rare mammals. *Australian Wildlife Research* **15**: 469-472.
- Sharifi, S. (2005) The Dormouse Monitor, spring issue, People's Trust for Endangered Species, London.
- Shawyer, C. R. (1996) *The Barn Owl and its habitat*. The Hawk and Owl Trust, London.
- Shore, R. F., Myhill, D. G., Lhotsky, R. & Mackenzie, S. (1995) Capture success for pygmy and common shrews (*Sorex minutus* and *Sorex araneus*) in Longworth and pitfall traps on upland blanket bog. *Journal of Zoology* **237**: 657-662.
- Slade, N. A., Eifler M. A., Gruenhagen N. M. & Davelos A. L. (1993) Differential effectiveness of standard and long Sherman live traps in capturing small mammals. *Journal of Mammalogy* **74**: 156-161.
- Southern, H. N. & Lowe, V. P. W. (1982) Predation by Tawny owls (*Strix aluco*) on bank voles (*Clethrionomys glareolus*) and wood mice (*Apodemus sylvaticus*). *Journal of Animal Ecology* **198**: 83-102.
- Southwood, T. R. E. (2000) *Ecological Methods*. Third edition. Blackwell Science, Oxford.
- Spencer-Booth, Y. (1963) A coastal population of shrews *C. s. cassiteridum*. *Proceedings of the Zoological Society of London* **140**: 322-326.
- Suckling, G. C. (1978) A hair sampling tube for the detection of small mammals in trees. *Australian Wildlife Research* **5**: 249-252.
- Tapper, S. C. (1976) Population fluctuations of field vole (*Microtus agrestis*) a background to the problems involved in predicting vole plagues. *Mammal Review* **6**: 93-117.
- Tapper, S. C. (1979) The effect of fluctuating vole numbers (*Clethrionomys glareolus*) on a population of weasels (*Mustela nivalis*) on farmland. *Journal of Animal Ecology* **48**: 603-617.
- Tattersall, F., Hart, B. J., Manley, W. J., Macdonald, D. W. & Feber, R. E. (1999) Small mammals on set-aside blocks and margins. *Aspects of Applied Biology* **54**: 131-138.
- Tattersall, F. & Whitbread, S. (1994) A trap based comparison for the use of arboreal vegetation by populations of bank vole (*Clethrionomys glareolus*), wood mouse (*Apodemus sylvaticus*) and common dormouse (*Muscardinus avellanarius*). *Journal of Zoology* **233**: 314-317.
- Taylor, I. (1994) *Barn Owls Predator-Prey Relationships and Conservation*. Cambridge University Press, Cambridge.

- Temple, R. & Morris, P. (1997) The lesser white-toothed shrew on the Isles of Scilly. *British Wildlife* **9**: 94-99.
- Toms, M. P., Siriwardena, G. M. & Greenwood, J. J. D. (1999) *Developing a Mammal Monitoring Programme for the UK*. British Trust for Ornithology, Thetford.
- Torre, I., Arrizabalaga, A. & Flaquer, C. (2004) Three methods for assessing richness and composition of small mammal communities. *Journal of Mammalogy* **85**: 524-530.
- Trout, R. C. (1978) A review of studies on wild Harvest Mice (*Micromys minutus* (Pallas)). *Mammal Review* **8**: 143-158.
- Twigg, G. I. (1975) Catching mammals. *Mammal Review* **5**: 83-100.
- Twigg, G. I. & Brown, J. C. (1975) Techniques in mammalogy *Mammal Review* **5**: 65-116.
- Village, A. & Myhill, D. (1990) Estimating small mammal abundance for predator studies - snap trapping v sign indexes. *Journal of Zoology* **222**: 681-689.
- Wallis, S. J. (1981) Notes on the ecology of the Orkney Vole (*Microtus arvalis orcadensis*). *Journal of Zoology* **195**: 532-536.
- Warner, L. J. & Batt, G. T. (1976) Some simple methods for recording wild harvest mouse (*Micromys minutus*) distribution and activity. *Journal of Zoology* **179**: 226-229.
- Wemmer, C., Kunz, T. H., Loudie-Jenkins, G. & McShea, W. J. (1996) Mammalian sign. In: *Measuring and monitoring biological diversity* (Ed. By D. E. Wilson, J. Nichols, R. Rudrin, R. Cole, & M. Foster), pp. 157-176. Smithsonian Institution Press, Washington, D.C.
- Wetton, J. H., Braidley, G.L., Tsang, C.S.F., Roney, C.A., Powell, S.L. & Spriggs, A.C. (2002) *Generation of a Species-Specific DNA Sequence Library of British Mammals - A study by The Forensic Science Service for The Joint Nature Conservation Committee and The Environment and Heritage Service, Northern Ireland*.
- Wheeler, P. (2002) *The distribution of mammals across the upland landscape* Unpublished Ph.D. thesis, University of Manchester.
- Wilkinson, S. A. J., Craze, P. G. & Harris, S. (2004) Monitoring field vole (*Microtus agrestis*) in lowland Britain. The Mammal Society Research Report No. 4 The Mammal Society, London.
- Williams, D. F., & Braun, S. E. (1983) Comparison of pitfall and conventional traps for sampling small mammal populations. *Journal of Wildlife Management* **47**: 841-845.
- Woods, M., McDonald, R. A. & Harris, S. (2003) Predation of wildlife by domestic cats *Felis catus* in Great Britain. *Mammal Review* **33**: 174-188.

7.1 Personal communications

Dr Roger Quay

Barry Sheard (NPTA)

Nick Andrews (Alderney Wildlife Trust)

Dr Rachel Ansell

Alasdair Love

Dr Michael Pocock

Nick Askew

Hazel Ryan

Dr Catherine O'Reilly

Dr Louise Magris